



mahindra
ROXOR HDUV

2023-2024
OPERATOR'S GUIDE

WARNING

Breathing diesel engine exhaust can expose you to chemicals known to the State of California to cause cancer and birth defects or other reproductive harm.

- Always start and operate the engine in a well-ventilated area.
- If in an enclosed area, vent the exhaust to the outside.
- Do not modify or tamper with the exhaust system.
- Do not idle the engine except as necessary.

For more information go to www.P65warnings.ca.gov/diesel

WARNING

Operating, servicing and maintaining a passenger vehicle or off-road vehicle can expose you to chemicals including engine exhaust, carbon monoxide phthalates, and lead, which are known to the State of California to cause cancer and birth defects or other reproductive harm. To minimize exposure, avoid breathing exhaust, do not idle the engine except as necessary, service your vehicle in a well ventilated area and wear gloves or wash your hands frequently when servicing your vehicle.

For more information go to www.P65warnings.ca.gov/passenger-vehicle

WARNING

California Perchlorate Contamination Prevention Act This Off-Road vehicle may contain perchlorate materials-special handling may apply.

For more information go to www.dtsc.ca.gov/hazardous_waste/perchlorate/

Table of Contents

1	Introduction	1-1	Stopping the Engine and Parking.....	6-4
	Improvements	1-1	7 Important On-Product Labels	7-1
	Engine tampering statement.....	1-1	ANSI Labels.....	7-1
2	Getting Started	2-1	EPA Labels.....	7-4
3	Operator's Guide	3-1	Manufacturer Labels.....	7-5
4	Safety Alert Symbols.....	4-1	8 Riding Gear	8-1
5	Safety Information/General Precautions	5-1	Helmets and Eye Protection	8-1
	Avoid Carbon Monoxide Poisoning	5-1	Additional Riding Gear	8-2
	Avoid Diesel Fuel Hazards.....	5-1	9 Prepare to Ride.....	9-1
	Avoid Hot Part Hazards	5-2	Pre-Ride Inspection Checklist.....	9-1
	Accessories and Modifications.....	5-2	Post-Ride Inspection Checklist	9-3
6	Safe Operations and Responsibilities	6-1	10 Learning Your Vehicle	10-1
	Owner Responsibilities	6-1	11 Vehicle Controls	11-1
	Operator's Responsibilities	6-2	Primary Controls	11-1
	Passenger Responsibilities	6-2	Keys	11-1
	Occupant Restraint System.....	6-3	Ignition Switch	11-1
	Riding Carefully.....	6-3	Headlamp Switch.....	11-3
	Terrain Condition.....	6-3	Multifunction Gauge	11-3

Table of Contents

Additional Controls (as equipped).....	11-6	Rear Cargo Area.....	12-3
Steering Wheel	11-7	Tailgate	12-3
Accelerator Pedal.....	11-7	Fuel Reservoir Cap	12-4
Brake Pedal	11-7	13 Electrical Distribution.....	13-1
Clutch Pedal	11-8	14 Fuel (Diesel)	14-1
Gear Shift Lever	11-8	Fuel Requirements.....	14-1
Transfer Case Lever	11-8	Fueling Procedure	14-1
12 Equipment.....	12-1	15 Break in Period	15-1
Seat Belts.....	12-1	Operation During Break In	15-1
Driver's Seat.....	12-1	Tips for Maximizing Durability.....	15-1
Passenger Seat.....	12-1	16 Avoiding Accidents.....	16-1
Rollover Protective Structure (ROPS)	12-1	17 OFF-Road Operation.....	17-1
Shoulder Guards (as equipped).....	12-2	18 General Driving Techniques	18-1
Side Nets / Doors	12-2	Driving Tips.....	18-1
Passenger Handhold.....	12-2	Driving in Reverse.....	18-1
12 Volt Power Outlet.....	12-3	Driving in or on Slippery Surfaces	18-2
Storage Compartments.....	12-3	Driving in or on Sand	18-2
Cup Bottle Holders.....	12-3	Driving in or on Snow or Ice.....	18-3

Table of Contents

Driving on Hills and Slopes.....	18-3	Towing.....	20-2
Side Hilling.....	18-4	21 Lifting and Supporting.....	21-1
Drop Offs.....	18-4	22 Maintenance.....	22-1
Crossing Obstacles.....	18-4	Severe Dusty Conditions.....	22-1
Crossing Shallow Water.....	18-5	Scheduled Maintenance Chart.....	22-2
Crossing Public Streets, Roads, or		23 Maintenance Procedures.....	23-1
Highways.....	18-5	Maintenance Tips and Precautions.....	23-1
Driving on Pavement.....	18-5	Clean Spark Arrester.....	23-1
Group and Distance Riding.....	18-6	Clean and Inspect Brakes.....	23-2
Environment.....	18-6	Check Brake Fluid Level and Leak Check.....	23-3
19 Moving Loads and Doing Work.....	19-1	Check Differential Oil Levels and Leak	
Working with Your ROXOR.....	19-1	Check.....	23-4
Weight and Load Limits.....	19-1	Check Engine Coolant Level and Leak	
Loading the Rear Cargo Area.....	19-1	Check.....	23-4
Carrying Loads.....	19-2	Check Engine Oil Level and Leak Check.....	23-5
Hauling and Pulling Loads.....	19-2	Check Power Steering Oil Level and Leak	
20 Transporting.....	20-1	Check.....	23-6
Trailerling.....	20-1	Check Tire Pressure.....	23-7

Table of Contents

Check Transfer Case Oil Level and Leak Check	23-8	Noise Emission Control System	25-1
Drain Fuel/ Water Separator.....	23-8	Acts Presumed to Constitute Tampering.....	25-2
Lubricate Shift Linkage	23-9	26 Specifications.....	26-1
Accessory Drive Belt Tension/ Replacement	23-9	Fluid Specifications and Quantities.....	26-1
Replace Engine Air Filter	23-11	Vehicle Specifications	26-2
Replace Engine Oil and Oil Filter	23-12	27 Troubleshooting.....	27-1
Replace Transfer Case Oil	23-13	28 Limited and EPA Warranties U.S. and Canada	28-1
Rotate Wheels and Tires	23-14	Mahindra Emissions Control Warranty Policy	28-1
24 Vehicle Care.....	24-1	29 Contact Us	29-1
Post Operation Care.....	24-1	30 Privacy Information.....	30-1
Vehicle Cleaning and Protection.....	24-1	31 Change of Address/Ownership	31-1
Metal and Rust Prevention	24-1	32 Stolen Units	32-1
Storage and Preseason Preparation	24-1		
25 Technical Information.....	25-1		
Product Identification Number	25-1		
Engine Identification Number.....	25-1		



1 Introduction

Congratulations on the purchase of your new Mahindra ROXOR Offroad Side x Side. Please know that **Mahindra USA, Inc d/b/a "MAGNA" (sometimes referred to as "Mahindra" here in after)** backs this unit with limited and EPA warranties. A network of ROXOR authorized dealers are ready to provide the parts, accessories and services to support your needs.

Upon delivery, you were informed of these limited and EPA warranty coverages and signed the Pre-Delivery Checklist to ensure your new ROXOR was prepared to your entire satisfaction. Please make sure you have a copy of the Pre-Delivery Checklist and retain it for your records. If you have questions or need more information, please contact your ROXOR authorized dealer or visit our website WWW.ROXOROFFROAD.COM.

1.1 Improvements

MAGNA's policy is one of continuous improvement, and the right to change prices, specifications or equipment at any time without notice is reserved.

All data given in this book is subject to production variations. Dimensions and weight are approximate only and illustrations do not necessarily show vehicles in standard conditions. For exact information about your particular ROXOR, Please consult your Mahindra Dealer.

1.2 Engine tampering statement

NOTICE

The fuel system and engine on your machine are designed and built to government emissions standard.

Tampering by dealers, customers, operators and users is strictly prohibited by law. Failure to comply could result in government fines, rework charges, invalid warranty, legal action and possible confiscation of the machine until rework to original condition is completed. Engine service and/or repairs must be done by a certified technician only.



2 Getting Started

Start by learning how to help reduce the risk of an accident affecting you, your passengers or bystanders. Read and make sure you fully comprehend and abide by the content of this Operator's Guide before you operate the Mahindra ROXOR Offroad Side x Side.

Also, read and become familiar with all safety labels on your ROXOR. Failure to follow all on-product safety label warnings, and the warnings contained in this Operator's Guide may result in severe injury or death of the operator, passengers and bystanders.



3 Operator's Guide

This Operator's Guide has been prepared to familiarize the owner and any operator with the various controls, maintenance and safe operating instructions. It is essential for the proper use of the product.

The information contained in this Operator's Guide is correct at the time of publication. MAgNA, however, maintains a policy of continuous improvement of its products without imposing upon itself any obligation to install them on products previously manufactured. We reserve the right to change, modify, or cancel specifications, designs, features, and colors without notice or obligation. Some differences between the manufactured product and the descriptions and/or specifications may exist.

Keep this Operator's Guide with the vehicle so you and any other operator can refer to it for things such as maintenance, troubleshooting and instructing others. To view and/or print extra copies of the Operator's Guide, simply visit WWW.ROXOROFFROAD.COM.

4 Safety Alert Symbols

This safety alert symbol indicates a potential for injury hazard. The categories of safety and informational labels provided on the ROXOR and in this Operator's Guide are defined as follows:

DANGER

potential for an immediate hazard resulting in severe injury or death to occupants and/or the general public if not avoided.

WARNING

potential for a hazardous condition exists that could result in severe injury or death of occupants and/or the general public if not avoided.

CAUTION

potential for a non-immediate hazard presenting a lesser threat of injury, resulting in minor or moderate injuries to occupants and/or general public if not avoided.

NOTICE

potential for a non-immediate hazard presenting a risk to property and/or equipment damage.

The entire contents of this Operator's Guide should be treated as safety instructions. They should be scrupulously adhered to, and where specifically warranted, we have called out instructions with the symbols above. However, failure to use proper care and abide by the contents of this Operator's Guide, as well as the applicable laws and regulations in your area, could result in severe injury, including death.



5 Safety Information/General Precautions

5.1 Avoid Carbon Monoxide Poisoning

All engine exhaust contains a deadly gas known as carbon monoxide. Carbon monoxide is a colorless, odorless, tasteless gas that may exist even though you may not see or smell engine exhaust. Breathing carbon monoxide can result in headaches, dizziness, drowsiness, nausea, confusion and could eventually lead to death. Lethal levels of carbon monoxide can collect quickly and exist for long periods of time when not properly ventilated. Always run the ROXOR in a well ventilated or open area.

DANGER

If you have symptoms that you think could be a result of carbon monoxide poisoning, leave the area right away, and call or go to the emergency room. If you keep breathing carbon monoxide fumes, you may pass out and die.

DANGER

Avoid running the engine in garages, carports or barns that do not have proper ventilation. Avoid running the engine anywhere that may allow exhaust gases to be drawn into a building through open doors, windows or vents resulting in the carbon monoxide poisoning of yourself or others.

5.2 Avoid Diesel Fuel Hazards

Diesel fuel is widely regarded as safe to handle and store in its liquid form. However, diesel fuel in its vapor form can be dangerous, especially at temperatures above 100° F (38° C). The vaporization rate of diesel fuel increases as the temperature increases. In the presence of a vapor accelerant such as fan forced air or oxygen, the diesel fuel can begin to vaporize even faster. Help reduce the risk of diesel fuel hazards by following these instructions.

- Strictly adhere to the fueling instructions in section 14.2 Fueling Procedure
- Never start or operate the engine if the fuel cap is not properly installed
- Use only an approved (yellow) diesel fuel container to store and transfer diesel fuel

WARNING

All fuel handling must take place in a well-ventilated area. Avoid heat, flames and other sources of ignition, avoid inhalation of vapors and contact with skin and eyes, do not siphon diesel fuel by mouth, never fill a fuel container inside the ROXOR as the interior surfaces are coated, acting as an insulator and allowing static electricity to build up, help guard against static discharges by always filling approved containers on the ground, do not allow anyone to remain in the ROXOR while fueling, an occupant may not be able to leave the area quickly in an emergency, failure to follow these warnings may result in severe injury or death.



5.3 Avoid Hot Part Hazards

The engine, exhaust, transmission, cooling system and other ancillary parts on the ROXOR become very hot during operation. Burns from touching these parts can happen in less than one second, but can be very serious. Help reduce the risk of burns by avoiding contact with these areas and other very hot parts, during and shortly after operation. If a burn occurs from contact with these areas follow these instructions:

- Use cool water on the burned areas. Avoid ice and cold water
- Clean the burn area immediately, and keep the area clean
- Cover or wrap the burn with a clean dry gauze pad
- For severe burns, call 911 and get medical attention right away

WARNING

Avoid contact with the engine, exhaust, transmission, cooling system and other very hot parts, during and shortly after operation to prevent burns and any other severe injury.

5.4 Accessories and Modifications

It is important to take the time to get familiar with the ROXOR once authorized and approved modifications are made, to help understand how to adapt your driving behavior accordingly. MAGNA parts and accessories have been specifically designed for use on the Mahindra ROXOR Offroad Side x Side. We strongly recommend that all parts and accessories you add to your ROXOR be genuine Mahindra parts and accessories, so as not to affect your safety, EPA compliance or factory limited warranty.

MAGNA warrants that the Accessories, as further defined below, are free from defects in material and workmanship:

for ninety (90) days from the date of purchase, if purchased by consumer without installation by a ROXOR authorized dealer; or

For the period and under the conditions described in section **28.1 Limited Warranty U. S. and Canada** if factory installed, or installed by a ROXOR authorized dealer.

Do not tamper with unauthorized modifications or install equipment not specifically certified by MAGNA for the ROXOR. These modifications have not been tested by MAGNA and they may increase emissions, risk of injury, loss of control or render the ROXOR illegal to use or operate.

As an example, tampering with tire specifications or ride height (lift kit) may affect the behavior of the ROXOR and increase the risk of roll over and loss of control. If you have questions, consult your local authorized dealer for suitable, available accessories for your ROXOR.



WARNING

The ROXOR was certified to EPA emissions and voluntary safety standards; Any unapproved modifications or addition of accessories may affect the certifications, emissions, safety and handling resulting in injury or death.

NOTICE

Any changes to factory installed wheel and tire size will adversely affect the operation of this unit's Dash Cluster and Engine Control Unit (ECU). Altering the Dash Cluster and/or ECU may cause driveability issues and potentially void the unit's warranty. Consult an authorized ROXOR Dealer for more information.



6 Safe Operations and Responsibilities

The ROXOR is an off-road work horse. Operators must be responsible and use care to avoid rollovers, tip overs, collisions, and other accidents.

Even with vehicle safety features such as a Rollover Protective Structure (ROPS), seat belts, shoulder guards, side nets, doors (if equipped) and protective gear such as helmets and eye protection.

There is always a risk of injury or death in these accidents. To help reduce the risk of severe injury or death, carefully follow the rules in this section.

6.1 Owner Responsibilities

Read this Operator's Guide and take advantage of the resources provided on the Recreational Off-Highway Vehicle Association (ROHVA) website (<http://www.rohva.org>).

Always inspect and confirm the safe operating condition of your ROXOR prior to a ride. Always follow the maintenance schedule described in this Operator's Guide.

Never allow anyone to operate your ROXOR unless they are responsible and can be trusted with an off-road vehicle like the ROXOR. Consider supervising new operators and setting rules and limits for anyone using your ROXOR (e.g., whether they can carry a passenger(s), what they may do with the vehicle, where they may ride, etc.).

Always discuss the safety information with anyone who will be using the ROXOR. Be sure that the operator and passenger(s) meet the qualifications below and agree to follow the safety information herein. Help users become familiar with the ROXOR and its equipment.

We encourage you to have an Annual Safety Inspection of your ROXOR. Please contact a ROXOR authorized dealer for further details. Though not required, it is recommended that a ROXOR authorized dealer performs the preseason preparation of your ROXOR. Each visit to your authorized dealer is a great opportunity for your dealer to verify if your vehicle is included in any campaigns. We also urge you to visit your authorized dealer in a timely manner if you become aware of any safety related campaigns.

6.2 Operator's Responsibilities

Read this Operator's Guide and take advantage of the resources provided on the ROHVA website [<http://www.rohva.org>]. Become completely familiar with the operational controls and the general operation of the ROXOR. Take a training course if available, contact a ROXOR authorized dealer to find out about training course availability in your area. New operators of the ROXOR should also perform the exercises in section 10 Learning Your Vehicle. Practice driving in a suitable area free of hazards and feel the response of each control. Drive at low speeds. Higher speeds require greater experience, knowledge and suitable riding conditions.

All operators must have a proper driver's license in accordance with local laws. Be tall enough to be properly seated: back against the backrest with the seat belt fastened, hold the steering wheel with both hands and still be able to reach the full stroke of clutch, brake and accelerator pedals with the correct foot. Never use the ROXOR while consuming or under the influence of drugs or alcohol, or if tired or ill. These effectively slow your reaction time and impair judgment.

WARNING

Operators must be at least 16 years of age or older, with a valid driver's license. Children under the age of 16 may not have the physical or psychological capability to operate the ROXOR without risk of injury or death.

6.3 Passenger Responsibilities

All passengers must be properly seated in their seats and be tall enough to always be properly seated: back against the backrest with seat belt fastened and feet firmly planted on floor. Never carry any passenger who is consuming or under the influence of drugs or alcohol, tired or ill. These effectively slow reaction time and impair judgment. Instruct all passengers to read the vehicle's safety labels. Never carry any passenger if you believe their ability or judgment is insufficient to concentrate on the terrain conditions and adapt accordingly. More specifically for off-road vehicles such as the Mahindra ROXOR Offroad Side x Side, the passenger must also pay constant attention to the terrain ahead and be able to brace for bumps.

WARNING

Never exceed seating capacity of one person per seatbelt. Failure could result in an un-belted passenger being ejected from the vehicle causing severe injury or death.



6.4 Occupant Restraint System

The ROXOR is designed to carry one person per seat belt, all wearing proper protective gear. Refer to section 8 Riding Gear for more information. The operator and passengers must latch the side nets or close full doors (if equipped) and wear seat belts at all times when riding.

NOTICE

If driver's seat belt is not fastened when the ignition is turned on, the seat belt indicator lamp will illuminate, and flash when driving.

6.5 Riding Carefully

The ROXOR handles differently from other vehicles. A collision or rollover can occur quickly, particularly during abrupt maneuvers such as sharp turns, hard acceleration or deceleration, and driving on hills or over obstacles if you fail to take proper precautions. Never operate at excessive speeds. Always go at a speed that is proper for the terrain, visibility, and operating conditions, as well as your experience. Never attempt jumps, side slides, donuts or any other stunts. Never attempt rapid acceleration or deceleration when performing a sharp turn. This may result in a rollover. Never attempt skidding or sliding. If the vehicle starts to skid or slide, counter steer in the direction of skidding or sliding. On extremely slippery surfaces, such as ice, go slowly and be very cautious in order to reduce the chance of skidding out of control. Always be sure there are no obstacles or people behind the vehicle when you operate in reverse. Pay attention to blind spots. When it is safe to proceed in reverse, go slowly. Never exceed the stated load limits for this vehicle. Cargo must be properly secured. Reduce speed,

allow for greater braking distance and follow all instructions in section 19 Moving Loads and Doing Work. Always remember that the ROXOR is heavy! Its pure weight alone may entrap you should it tip or rollover.

6.6 Terrain Condition

The ROXOR is not equipped for, or legal to operate on, public streets, roads, or highways. If you must use the ROXOR on public streets, roads, or highways, avoid abrupt inputs to the steering wheel, accelerator pedal and brake pedal. Be alert of motor vehicles that are equipped for on road use, as the ROXOR is not.

Take the time to learn how the ROXOR performs in different environments by reading and comprehending section 18 General Driving Techniques. Check the terrain carefully before you start up and down hills, enter or exit water, or drive through tall grasses when the surface texture is not visible. Remember that wet brakes may have reduced stopping ability. Test your brakes after leaving water and if necessary, apply them several times to let friction dry out the brakes.

Sudden changes in terrain caused by holes, depressions, banks, softer or harder ground or other irregularities may cause the vehicle to roll over or become unstable. To avoid this, slow down and always observe the terrain ahead. If the ROXOR does begin to roll over, the best advice is to immediately steer in the direction of the rollover and do not attempt to prevent a rollover with your arms or legs. Always keep your limbs inside the Rollover Protective Structure (ROPS).



- Always ensure to properly park the ROXOR on the flattest terrain section available. Refer to section 6.7 Stopping the Engine and Parking
- Always go slowly and be extra careful when operating on unfamiliar terrain.
- Always be alert to changing terrain conditions.
- Always check for obstacles before operating in a new area.
- Always follow proper procedures for ascending or descending hills or crossing obstacles.
- Never assume that the ROXOR will go everywhere safely.
- Never operate on excessively rough, slippery or loose terrain.
- Never operate on hills too steep for your abilities. Practice on small inclines.
- Never go over the top of any hill at high speed.
- Never attempt steep hills or side hill traversing when pulling a trailer.
- Never operate in fast flowing water or in water deeper than specified in section **18.10 Crossing Shallow Water**

6.7 Stopping the Engine and Parking

Release accelerator pedal and use brakes to completely stop the ROXOR. Turn the ignition switch to the OFF position and remove key from ignition switch. When stopped or parked always put gear shift lever in first gear and set parking brake by pushing the button in, pulling straight up and then releasing button. To release parking brake, pull up slightly, push and hold button in, then release down to rest position and release button.

This is especially important when parking on a slope, you should always try to park on the flattest and most stable terrain available.

The nominal ground clearance for the ROXOR is 9" (22.9 cm).

WARNING

On very steep inclines the wheels should be blocked using rocks or logs to help prevent sliding, avoid loose wet or slippery sloped terrain to further help prevent the ROXOR from sliding, avoid stopping or parking in places where hot parts like the engine, exhaust, transmission or cooling system may start a fire, like tall dry grass. Failure to follow these warnings may result in severe injury or death.

7 Important On-Product Labels

Replacement labels can be requested from a ROXOR authorized dealer with a registered Product Identification Number (PIN).

WARNING

Removal of, or tampering with any of these important on-product labels is highly discouraged by Mahindra. Removal of these labels may result in operators missing critical safety instructions which may result in severe injury or death.

WARNING

A person who knowingly removes, obliterates, tampers with, or alters the Product Identification Number (PIN) on the ROXOR, with intent to further the theft of it pursuant to the Motor Vehicle Theft Prevention Act, shall be fined under this title, imprisoned not more than 5 years, or both.

7.1 ANSI Labels

The labels in this section are to comply with the requirements set forth by the American National Standards Institute (ANSI), specifically standard ANSI Z535.4-2007.

The ROXOR is delivered with several labels containing important safety information. Some of these labels are affixed to the ROXOR for the safety of the operator, passengers and bystanders. They need to be clean and visible at all times. If missing or damaged, they need to be replaced. Replacement labels are free of charge and can be requested from a ROXOR authorized dealer with a registered Product Identification Number (PIN).

NOTICE

Any hang tags shown in this section should only be removed by the ultimate consumer after purchase. Any person who operates, or is a passenger in the ROXOR should read and understand the information contained in the on-product labels before riding.





⚠ WARNING

IMPROPER TIRE PRESSURE OR OVERLOADING CAN CAUSE LOSS OF CONTROL, RESULTING IN SERIOUS INJURY OR DEATH.

- Never exceed max. vehicle load capacity.*
 - Never carry any passenger in rear cargo area.
 - Properly secure loads in rear cargo area.
 - Inflate tires to recommended pressure.
- An underinflated tire can come off the rim.

GVWR :	4600 lbs
MAX. VEHICLE LOAD CAPACITY*:	1525 lbs
TIRE PRESSURE (COLD) :	28 psi
TIRE PRESSURE (MIN) :	15 psi

* Max. vehicle load capacity includes weight of operator, passenger, accessories, trailer tongue (if applicable), and rear cargo.

To reduce the risk of loss of control or loss of load:

When loading cargo:

- Position cargo toward the front and center of cargo area, and as low as possible.
- Latch the tail gate before moving.

When carrying a load:

- Reduce speed and turn gradually.
- Avoid hills and rough terrain.
- Allow more distance to stop.

Refer to the Operator's Guide for more information.

TILT TABLE TEST RESULT
 Vehicle Model: ROXOR

40.0

The value above is a measure of the lateral stability, in degrees, of a sample, standard condition vehicle (with an operator/passenger load of 430 lbs. and when performed with factory installed tires), as determined by the manufacturer in accordance with the tilt table lateral stability test in the ANSI/ROHVA standard for Recreational Off-Highway Vehicles (ROVs).

Vehicle modifications, accessories, and loading can affect lateral stability.

Rollover cannot be completely eliminated for any vehicle.

Training courses to teach ROV driving are available. For information, contact your dealer or ROHVA.org.

Check with your dealer to find out about state or local laws regarding ROV operation.

THIS HANG TAG IS NOT TO BE REMOVED BEFORE SALE

⚠ WARNING

IMPROPER USE OF OFF-HIGHWAY VEHICLES CAN CAUSE SEVERE INJURY OR DEATH



NO OPERATOR UNDER AGE 16
 Locate and Read the Operator's Guide and all Safety Labels. Follow All Instructions and Warnings



BE PREPARED

- Fasten seatbelts and wear an approved helmet and protective gear.
- Make sure doors or nets are securely latched in place.
- Plan for hills, rough terrain, ruts, and other changes in traction and terrain.
- Stay completely inside the vehicle.
- Each rider must be able to sit with back against seat, feet flat on the floor or on footrest, and hands on steering wheel or handholds.
- If you think or feel the vehicle may tip or roll, reduce your risk of injury by keeping a firm grip on the steering wheel or handholds and brace yourself.
- Never put any part of your body outside the vehicle for any reason.

DRIVE RESPONSIBLY

- Rollovers have caused severe injuries and death, even on flat, open areas.
- Avoid loss of control and rollovers.
- Avoid abrupt maneuvers, sideways sliding, skidding, or fishtailing
- Avoid hard acceleration when turning, even from a stop.
- Never do donuts.
- Slow down before entering a turn.
- Avoid side hilling (riding across slopes).
- Avoid all public roads and paved surfaces.



PREVENT INJURIES

- Never allow careless or reckless driving.
- Never allow Operators under 16 years of age.
- Never allow anyone to drive or ride after using drugs or alcohol.
- Never allow operation on public roads, collisions with other vehicles can occur.
- Never exceed seating capacity. Maximum 2 occupants.

Mahindra

MAHINDRA NORTH AMERICAN TECHNICAL CENTER, INC.

THIS HANG TAG IS NOT TO BE REMOVED BEFORE SALE

⚠ WARNING - IMPROPER USE OF OFF-HIGHWAY VEHICLES CAN CAUSE SEVERE INJURY OR DEATH



BE PREPARED

- Fasten seatbelts.
- Wear an approved helmet and protective gear.
- Make sure doors or nets are securely latched in place.
- Each rider must be able to sit with back against seat, feet flat on the floor or on the footrest, and hands on steering wheel or handholds. Stay completely inside the vehicle.



REQUIRE PROPER USE OF YOUR VEHICLE

Do your part to prevent injuries:

- Operators must be 16 or older, with a valid driver's license.
- Never allow careless or reckless driving.
- Never allow anyone to drive or ride after using alcohol or drugs.
- Never allow operation on public roads (unless designated for off-highway vehicle access). Collisions with cars and trucks can occur.
- Never exceed seating capacity of one person per seatbelt.

Locate and Read the Operator's Guide. Follow All Instructions and Warnings.

⚠ WARNING - DRIVE RESPONSIBLY



Rollovers have caused severe injuries and death, even on flat, open areas.

AVOID LOSS OF CONTROL AND ROLLOVERS:

- Avoid abrupt maneuvers, sideways sliding, skidding, or fishtailing. Never do donuts.
- Slow down before entering a turn.
- Avoid hard acceleration when turning, even from a stop.
- Plan for hills, rough terrain, ruts, and other changes in traction and terrain. Avoid paved surfaces.
- Avoid side hilling (riding across slopes).

BE SURE RIDERS PAY ATTENTION AND PLAN AHEAD

If you think or feel vehicle may tip or roll, reduce your risk of injury:

- Keep a firm grip on the steering wheel or handholds and brace yourself.
- Never put any part of your body outside the vehicle for any reason.

⚠ WARNING

NEVER CARRY ANY PASSENGER IN THE CARGO AREA



7.2 EPA Labels

The labels in this section are to comply with the requirements set forth by the Environmental Protection Agency (EPA).

All EPA on-product labels with the ROXOR, should be considered a permanent part of the ROXOR. Upon replacement of parts that have EPA labels on them, make sure to order the applicable safety warning labels if not already installed on the replacement part.

The ROXOR is delivered with several labels containing important safety and emissions information.

They need to be clean and visible at all times. If missing or damaged, they need to be replaced. Replacement labels are free of charge and can be requested from a ROXOR authorized dealer with a registered Product Identification Number (PIN).



7.3 Manufacturer Labels

The labels in this section are driven by MAgNA's commitment to product safety and making sure the operator of the ROXOR is fully aware of its capacities and limitations.

The ROXOR is delivered with several labels containing important safety information. Some of these labels are affixed to the vehicle for the safety of the operator, passengers and bystanders. They need to be clean and visible at all times. If missing or damaged, they need to be replaced. Safety labels are free of charge and can be requested from MAgNA with a registered Product Identification Number (PIN).

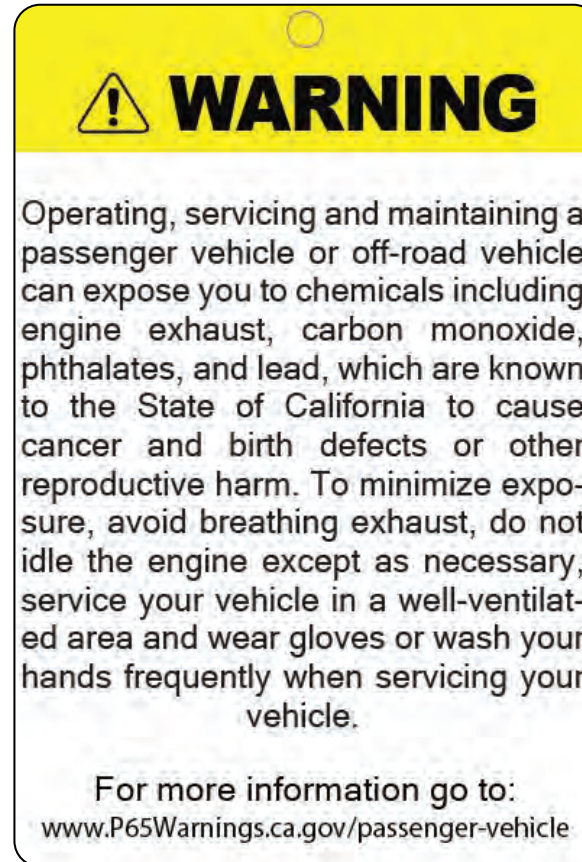
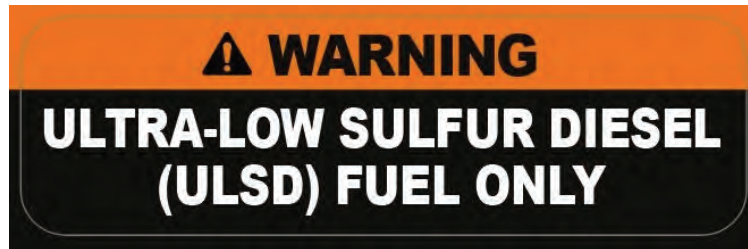

⚠ WARNING

**DON'T DO
ANYTHING
STUPID!**

Read the Operator's Guide

⚠ CAUTION

- Always keep battery on a tender when vehicle is not in use and/or subject to cold temperatures for an extended period of time.
- Always ensure battery cable terminals are tightened to (5N-m) before use or charging.
- Never jump-start a low battery unless charging is not an option.
- If jump-starting is required, ensure battery cable terminals are tight to battery posts of both vehicles.

8 Riding Gear

It is important that the operator and passengers always wear appropriate protective clothing and apparel, including an approved helmet, eye protection, boots, gloves, a long-sleeved shirt or jacket and long pants. Depending on conditions, anti-fogging eye protection may be required. Weather conditions should help you decide how to dress. To maximize comfort and avoid frostbite in winter, dress for the coldest weather expected. Thermal underwear next to the skin also provides good insulation. Never wear any loose clothing that may get entangled in the vehicle or on tree branches and shrubs.

8.1 Helmets and Eye Protection

Helmets protect you from head and brain injuries. Select a helmet that meets the Department of Transportation (DOT) safety standard in your state, province or country. A helmet should bear the standards DOT FMVSS 218 and/or ECE 22.05 and should fit snugly and fasten securely.

A helmet with full face protection is the best choice because it will protect your face from impacts. Branches, stones, insects and other flying objects cause injury to you and your passengers, as well as make you lose control of the ROXOR. For cold weather riding, a stocking cap or face mask will also offer protection from flying objects and the elements.

If you choose an open-face helmet, a snap on safety shield is preferred. An open-face helmet does not offer the same protection for the face and chin. The ROXOR's Roll Over Protection Structure (ROPS) and side nets cannot prevent all objects from entering the

cockpit area. In rough terrain conditions, your head may make contact with the ROPS or objects outside the ROXOR. The best helmet is no guarantee against injury, but statistically a helmet significantly reduces the risk of injury. Operator and passengers should always wear a helmet while riding in the ROXOR.

OSHA approved eye protection is also essential to see clearly and drive safely. Dust, dirt, rocks, bugs and branches not only distract and obstruct your vision but can permanently damage your eyesight. Most prescription eye glasses and sunglasses will NOT provide proper protection while driving the Mahindra ROXOR Offroad Side x Side. The lenses can shatter causing severe eye injury. Protective eye wear, goggles and face shields should bear one of the following standards, z87.1, z87.2, VESC8, V-8, or be made of a hard coated polycarbonate. Use tinted face shields or eye protection in the daytime only, use clear eye protection for driving at night.

WARNING

Do not use tinted lenses at night or in low light conditions as these will limit your ability to see terrain contour, which may result in severe injury or death.

WARNING

Do not use tinted lenses if they effect your ability to see color, this may also result in severe injury or death.



8.2 Additional Riding Gear

Riding in the ROXOR without the additional riding gear listed below increases your chances of severe injury in the event of an accident.

Hearing Protection – Check your local laws before using hearing protective devices as they may not be allowed. Hearing protective devices can help prevent hearing loss but also reduce your ability to hear the surrounding sounds and may affect your safety.

Gloves – Gloves protect your hands from the elements and flying objects. Properly fitting gloves will improve your grip on the steering wheel and reduce fatigue. If gloves do not fit properly they may make it difficult to operate the ROXOR controls. For cold weather riding, gloves with sufficient insulation are required to protect your hands from frost bite.

Boots – You should not operate the ROXOR with open toed footwear. An over the ankle boot with non-slip soles are preferred and will help you keep your feet firmly on the floor and foot controls. Long shoelaces should be avoided, they can get tangled in the foot controls and prevent you from exiting the ROXOR. For cold weather riding, avoid oversized boots that may get trapped in the foot controls and prevent the proper operation of the ROXOR.

Clothing – Long sleeve shirts and long pants are preferred when operating the ROXOR. In the event of a crash the right clothing may prevent or reduce injury. For cold weather riding, wear sufficient insulation to protect yourself against hypothermia, a condition of lowered body temperature resulting in a loss of concentration, slower reaction times and muscle movement. Even in moderate temperatures, wind chill can make you cold and affect your reaction time. A windproof outer layer can prevent this. Always dress in layers so that clothing can be added and removed to keep you comfortable during your entire ride.

Rain Gear – On extended rides, carrying rain gear is a good idea. Dry riders will be much more alert and comfortable.

9 Prepare to Ride

Before a ride, the operator should always perform a Pre-Ride Inspection to confirm the safe operating condition of the ROXOR. Refer to section 9.1 Pre-Ride Inspection Checklist. Operator and passengers must be properly seated, with both side nets latched and doors closed (if equipped) and seat belts fastened. Wear the appropriate riding gear. Refer to section 8 Riding Gear for more information.

WARNING

Perform a Pre-Ride Inspection before each ride to help detect any potential problems that could occur during operation. The Pre-Ride Inspection can help you monitor component wear and deterioration before they become a problem. Correct any problem that you discover to help reduce the risk of a breakdown or accident.

NOTICE

Always follow the maintenance schedule described in this Operator's Guide to also keep your vehicle in safe working order.

9.1 Pre-Ride Inspection Checklist

- What to do before starting the engine.
- Check tire pressure and condition. Recommended cold tire pressure is 28 psi.
- Check wheels for damage and abnormal play. Make sure lug nuts are torqued to between 71-105 Nm.
- Check cleanliness of radiator cooling fins.
- Check engine oil level. Maintain between the two notches on dip stick.
- Check engine coolant level. Maintain between HIGH and LOW lines on the coolant overflow bottle when engine is cold.
- Check brake fluid level. Maintain between MIN and MAX lines on the brake fluid reservoir with no pedal pressure.
- Check clutch fluid level. Maintain between MIN and MAX lines on the clutch fluid reservoir with no pedal pressure.
- Inspect the engine air filter, clean or replace if needed.
 - Service engine air filter more often in dusty conditions.
- If you are transporting cargo, respect the maximum rear cargo weight capacity.
 - Ensure cargo is properly secured in the rear cargo area.
 - Ensure maximum vehicle load capacity does not exceed specifications. This includes operator, passengers, added accessories, trailer tongue weight (if applicable), and rear cargo

- Check that the tailgate is properly latched.
- If you are pulling a trailer or other equipment, respect the trailer tongue capacity and towing capacity
 - Ensure trailer hitch and trailer ball are properly secured.
 - Ensure trailer is properly secured to trailer hitch and ball
 - Limit operation to safe level terrain.
- Check underneath vehicle for any debris on chassis or suspension and clean them properly.
- Check operation of indicator lamps.
 - This can be done during the first few seconds of key ON.
- Check operation and cleanliness of headlights and taillights
- Check operation of high and low beam headlights.
- Check operation of brake lights.
- Check that the seats are properly latched.
- Check side nets for any damage, fasten both side nets and confirm they latch securely. Use the adjustment strap to tighten nets as required.
- Check seat belts for any damage, fasten seat belts and confirm they latch securely
- Press on the accelerator pedal a few times to ensure it operates freely and it returns to the rest position when released.
- Press on the brake pedal and make sure you feel firm resistance and it returns to the rest position when released.

- Check the fuel level.
- Adjust mirrors to your preferences. (If equipped)

What to do after starting the Engine

- Check if steering wheel operates freely by completely turning it from side to side.
- Turn the ignition switch to OFF to verify if engine will shut down. Restart engine.
- Check for smooth and free operation of shift lever.
- Check for smooth and free operation of 2WD 4WD selector.
- Drive forward slowly a few feet and apply brakes. The brake pedal must feel firm when applied. The pedal must return to rest position when released. The brakes must respond adequately to the operator's input.
- Check parking brake operation.
- Inspect all accessory drive belts for damage, wear, contamination, or improper tension and adjust as necessary.

WARNING

Damaged or missing seat belts, shoulder guards and side net's or doors should be replaced immediately to help prevent an occupant from being ejected, resulting in severe injury or death.

NOTICE

Refer to section 26 Specifications for more information on fluid volumes and specifications.



Refer to section 23 Maintenance Procedures for more detailed instructions where applicable.

9.2 Post-Ride Inspection Checklist

Always inspect and confirm your ROXOR and safety devices have not been damaged after a ride. Always follow the maintenance schedule described in this Operator's Guide.

What to Do After Stopping the Engine

- Clean the ROXOR and lubricate all moving parts.
- Let drivetrain cool and then check fluid levels, top off as necessary.
- Inspect and remove all dirt and debris from your engine, transmission, exhaust and other components that can get hot during a ride.
- Check for fluid leaks in the engine compartment and under the ROXOR.
- Properly park the ROXOR on the flattest surface available.
- Put gear shift lever in first gear and set parking brake by pushing the button in, pulling straight up and then releasing button.
- Remove the ignition key before leaving the ROXOR.

CAUTION

Verify that the ignition key is in the OFF position. If left in the ON position for extended periods of time electrical loads can drain the battery and cause the vehicle to not start when needed.



10 Learning Your Vehicle

MAGNA recommends that you contact your local ROXOR authorized dealer for information about ORV training courses in your area, or visit the Recreational Off-Highway Vehicle Association (ROHVA) website (<http://www.rohva.org>). All operators should familiarize themselves with the handling of the Mahindra ROXOR Offroad Side x Side in a controlled environment before they go off-roading. Find an area free of obstacles to practice and perform the exercises listed below. And never perform these exercises with a load in the cargo area or with a trailer attached.

Starting the Engine – Depress clutch fully, insert the ignition key into the ignition switch, then turn the ignition key to the START position. Release the ignition key immediately when the engine has started.

Do not hold ignition key in START position for more than 10 seconds at a time, as this can overheat the starter and damage it. Improper use may result in a limited warranty claim being denied.

WARNING

Never use an engine starting aid such as ether. Engine damage will result which would void all of your warranty coverage.

NOTICE

If the engine does not start after repeated attempts, refer to section 27 Troubleshooting.

Manual Transmission – If you have never driven a vehicle with a manual transmission, learning on the ROXOR while driving off-road is not advisable. A manual transmission requires the operator to shift gears themselves, with proper timing and coordination. This activity must become second nature, in a controlled environment, before operating on difficult terrain.

The clutch pedal is located at the far left and is required to shift gears. Always fully depress the clutch pedal while shifting gears, then gradually release the clutch pedal to engage the transmission while increasing the engine idle to around 1500 RPM. Change one gear at a time in ascending or descending order. As a general rule, you should shift gears about every 10 mph increase or decrease in speed. When switching from a forward gear to reverse, or from reverse to a forward gear, come to a complete stop.

WARNING

Never try to start the ROXOR without being seated in the driver's seat with the clutch pedal fully depressed and the parking brake set to help prevent a runaway situation in the event the throttle is stuck.

Turning – Overly aggressive turning frequently results in accidents. You should practice turning in both directions at various speeds to experience the lateral force differences. Speed and steering input will affect lateral force, and should try to minimize this force for safety. Decelerate before entering a turn and accelerate slowly as you exit the turn. You should also practice U-turns and turning while driving in reverse.



Braking – It is important to get familiar with the braking response on the ROXOR. Start at slow speeds and low pedal force. Gradually increase your speed and pedal force to understand adequate braking distance without locking up the wheels. It may also be a good idea to practice an emergency stop to see how the ROXOR reacts. Always brake in a straight line with little to no steering input.

Reverse – Learn how the ROXOR handles in reverse and more importantly how it reacts to steering inputs while driving in reverse. You should also familiarize yourself with the distance required to see obstacles behind you. Place an orange cone or other non-destructible item close to the rear bumper and then pull forward until you can see the item from the driver's seat. You can even practice backing up to these items without hitting them. Take note of the distances.

Emergency Engine Stop – While driving at a slow speed, turn off the ignition switch. Take note of how the ROXOR reacts when the engine stops running. It is a good idea to develop this reflex in case of an emergency. You may also want to practice an emergency exit, which will require stopping the engine, immobilizing the ROXOR, removing the seat belt, detaching the safety net (or opening the door) and exiting the ROXOR.

11 Vehicle Controls

11.1 Primary Controls

All operators should familiarize themselves with all of the controls on the Mahindra ROXOR Offroad Side x Side, in a controlled environment, before going off-road. Find a flat area free of obstacles to practice and perform the exercises listed in section 10 Learning Your Vehicle. Emphasis should be placed on the development of smooth and coordinated use of these controls, knowing their locations and understanding their function.

11.2 Keys

The ROXOR is delivered with keys for ignition, storage compartment, and (as equipped) door keys.

NOTICE

Neither of these two lockable storage compartments is waterproof. All electronics or other valuables stored in these compartments should be adequately protected by other means.

11.3 Ignition Switch

The ignition switch is located on the dash panel to the right of the steering wheel.

OFF position – in this position the electrical system is disabled and the engine will shut off.

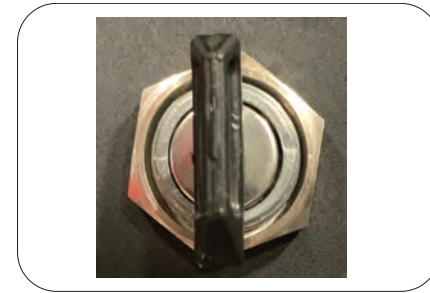

NOTICE

You should only be able to insert and remove the ignition key when the ignition switch is in the OFF position. If this statement is not true, contact and return your ROXOR to an authorized dealer.

ON position – in this position all Accessory functions are activated as well as the instrument cluster and engine controls. When starting in cold climates, the ignition key should remain in this position for several seconds to allow time for the engine intake heater to aid starting.



NOTICE

The ignition key should automatically return to this position when released from the start position. If this statement is not true, contact and return your ROXOR to an authorized dealer.

START position – in this position the starter is engaged. You should only hold the ignition key in this position until the engine starts, then release the ignition key

NOTICE

Do not hold the ignition key in the START position for more than 10 seconds at a time, as this can overheat the starter and damage it. You should allow 10-15 seconds between attempts to preserve the starter and battery.

NOTICE

If the engine does not start after repeated attempts, refer to section 27 Troubleshooting.

11.4 Headlamp Switch

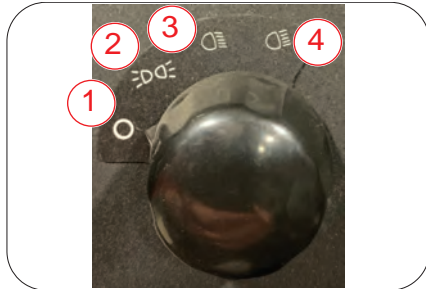

A four position dial switch is used to control the head lights on the ROXOR.

- First position from left - Lights Off
- Second position - Tail Lights only
- Third position - Low Beam Headlights
- Fourth position - High Beam Headlights

11.5 Multifunction Gauge



Speedometer -large digital readout in center of gauge that indicates vehicle speed in miles per hour or kilometers per hour.

Odometer -digital readout below the speed that records the total distance traveled in miles or kilometers

Trip Odometer - using the same digits as the Odometer, there are two available trip odometers (A & B) switchable using the Mode Button

Hours Meter - the total hours on your vehicle will display below the fuel level indicator, only when the ignition key is in the ON position and the engine is off.



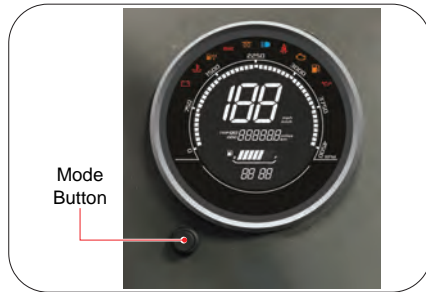

Tacho Meter -using the same display as the hours, this displays the engine rpm only when the engine is running. It is also displayed in a radial bar graph around the digital readouts.

Mode/Units Button - located at the bottom left of the cluster, this cycles between the Odometer and Trip Odometers A & B. When in the Odometer mode, pressing and holding the button for 5-10 seconds will switch the units between miles and miles/hr to kilometers and kilometers/hr.



Indicator Lights:

	<p>Oil Indicator - red light on steady when the oil pressure is below a safe level.</p>
	<p>Seat Belt Indicator - red light on steady when the driver's seat belt is unbuckled, and light will flash when the vehicle is driven.</p>
	<p>Low Fuel Indicator - yellow light on steady when fuel level is at two gallons or less. Light flashes when fuel level sensor has failed to provide a signal.</p>
	<p>Check Engine Indicator - yellow light on steady or flashing when an emissions related trouble code has been set, return vehicle to an authorized Mahindra dealer for service.</p>
	<p>Water In Fuel Indicator - yellow light on steady when water reached sensor contacts in the fuel filter canister, drain water from fuel separator.</p>
	<p>Engine Coolant Temperature Indicator - red light flashes when engine coolant temperature reaches 230°F (110°C) and stays on steady at 248°F (120°C) or above. Light will go off when engine coolant temperature drops below 221 °F (105°C).</p>

	<p>Charging System Indicator - red light on steady when there is less than 12 volts. This can indicate a charging system failure, check alternator and/or battery. This light will be on when the ignition key is in the IGN ON position but the engine is not running. It may also remain ON for up to 130 seconds after start in cold weather due to intake heater operation.</p>
	<p>Brake System Indicator - red light on steady when the brake fluid level is below the minimum level or the parking brake is set.</p>
	<p>Wait To Start Indicator - when the key is in IGN ON position the yellow light is on steady for up to 100 seconds in extreme cold temperatures. Engine intake air heater is on due to engine temperature, wait for light to go out before cranking.</p>
	<p>High Beam Head lamp Indicator - blue light on steady when headlamp switch is in the high beam position.</p>

Fuel Gauge:



- 7 bars - 92% or more in fuel tank
- 6 bars - 80% or more in fuel tank
- 5 bars - 69% or more in fuel tank
- 4 bars - 56% or more in fuel tank
- 3 bars - 42% or more in fuel tank
- 2 bars - 28% or more in fuel tank
- 1 bar - 16% or more in fuel tank
- 0 bars - ~2 gallons or less remaining

11.6 Additional Controls (as equipped)

Windshield Wipers - A simple ON/OFF toggle switch for controlling the windshield wipers is located on the dash panel to the left of the steering wheel.



HVAC System - The control for the Heating, Ventilation, and Air Conditioning system is located at the bottom of the dash panel below the instrument cluster.



There are three controls with the left-most being a 4-position dial for fan speed (OFF, Low, Medium, and High). When Heat is desired, the middle knob should be pulled out. If Air Conditioning is

desired, the middle knob should be pushed in and the right dial can be adjusted for desired temperature (clockwise for cooler temperature).

There are six forward-facing air registers and two bottom-facing registers located at the bottom of the dash panel on the passenger side. In addition, there are two defrost registers at the top of the dash panel, one at the center, and the other on the passenger side.

For the most efficient warmup, it is recommended that all of the registers remain closed with only the bottom two registers open until the system is warm. If defogging or defrosting the windshield is desired, the Air Conditioning must be turned on to de-humidify the air.



Light Bar– A simple ON/OFF toggle switch for controlling the roof mounted light bar is located on the dash panel to the left of the steering wheel.



11.7 Steering Wheel

The steering wheel is located on the driver's side of the vehicle, in front of the driver's seat. Use the steering wheel to control your direction when moving forward and backward. Grip the steering wheel with both hands, and never wrap your thumbs around the steering wheel.

CAUTION

Under rough trail conditions or when crossing an obstacle, the steering wheel could suddenly jerk in one direction or the other. Grip the steering wheel with both hands, without having thumbs wrapped around the steering wheel. Hand and/or wrist injuries may occur if the thumbs are wrapped around the steering wheel.

11.8 Accelerator Pedal

Of the three pedals located on the driver's side floor area, the accelerator pedal is on the far right. The accelerator pedal controls the engine speed and should be operated smoothly and reasonably. The accelerator pedal is spring loaded and should return to its rest position (idle) when not pressed. Take your ROXOR to an authorized dealer if you are experiencing problems.

11.9 Brake Pedal

Located in the driver's foot well area, the brake pedal is the middle pedal. Use the brake pedal to slow down or stop the ROXOR. When driving a manual transmission it is preferred to use your right foot to operate this pedal. It is spring loaded and should return to its rest position (little to no rolling resistance) when not pressed.

NOTICE

If the ROXOR will not move with your foot off of the brake pedal, first check and release the parking brake. Next make sure the transmission is in gear. If neither of these work, take your ROXOR to an authorized dealer.

11.10 Clutch Pedal

Of the three pedals located on the driver's floor area, the clutch pedal is on the far left. To disengage the clutch, fully depress the clutch pedal when shifting gears. Don't grind the gears during shifting, this may result in damage to the gears. Do not allow your foot to rest on the pedal when not using the clutch. This can overheat the clutch plates and result in premature clutch failure. You should avoid these habits as they may result in having a limited warranty claim denied due to improper use.

WARNING

Never try to start the ROXOR without being seated in the driver's seat with the clutch pedal fully depressed and the parking brake set to help prevent a runaway situation in the event the throttle is stuck.

11.11 Gear Shift Lever

The shift pattern for a Manual Transmission is located on top of the gear shift lever knob. Use the gear shift lever to shift between forward gears and access reverse. When shifting gears, always depress the clutch fully and let up on the accelerator pedal before moving the gear shift lever to the next gear.

NOTICE

Bring the ROXOR to a complete stop with engine running before shifting into reverse to prevent gear damage and ease engagement.

11.12 Transfer Case Lever

The transfer case shift pattern is located on top of the transfer case lever knob. Use the transfer case lever to switch between 2WD and 4WD operation. 4WD has a Low range and High range.

4WD Low range allows the vehicle to drive at much slower speeds while still operating within the usable power band / RPM range of the engine. This also increases the torque available at the axles. Low range gears should be used during slow speed or extreme off-road conditions.

NOTICE

Bring the ROXOR to a complete stop with engine running before shifting the transfer case into 4WD Low Range to prevent gear damage and ease engagement. The ROXOR can be shifted between 2WD and 4WD High ranges at any speed.

CAUTION

Engage the front axle when operating with both the transmission and transfer case in low gear to prevent excessive torque loads on the rear axle. Disengage the front axle when operating on dry hard surfaces.

12 Equipment

12.1 Seat Belts

The ROXOR is equipped with 3-point seat belts to help protect operator and passengers in the event of a collision, rollover, or tip over. The seat belts can help occupants stay in the cockpit area. The seat belts are equipped with a semi-cinching tab that locks the lap belt when the webbing is under tension. To fasten the seat belt, insert the latch plate into the buckle, then pull the belt to ensure it is properly fastened. Adjust the seat belt tightly against your body by pulling the shoulder belt upwards.

WARNING

Wear seat belts properly and keep side nets secured at all times. Seat belts help reduce the risk of severe injury in a crash and help keep limbs inside the cockpit in a rollover or any other types of accidents.

NOTICE

If driver's seat belt is not fastened when the ignition is turned ON, the seat belt indicator lamp will illuminate, and flash when driving.

12.2 Driver's Seat

The driver's seat can be adjusted forward and backward. To adjust seat, move the seat lever up to unlock the seat. Release the lever to lock the seat into desired position.

WARNING

To help prevent a loss of control, never adjust the seat position while driving. A loss of control while driving could result in severe injury or death.

12.3 Passenger Seat

The passenger's seat can be adjusted forward and backward. To adjust seat, move the seat lever to unlock the seat. Release the lever to lock the seat into desired position.

WARNING

There is no indicator light or message for the passenger's seat belt (s). The operator is responsible for the passenger's safety and should ensure all passengers buckle their seat belt, secure their side net and keep their limbs inside the vehicle to help prevent severe injury or death.

WARNING

Never adjust the seat position while moving, this could result in personal injury.

12.4 Rollover Protective Structure (ROPS)

The ROXOR is equipped with a tubular frame over the cockpit called the ROPS (Rollover Protective Structure). It is designed to help keep the operator and passengers restrained and help provide protection to the cockpit.

WARNING

The ROPS is an integral part of the safety system and must not be removed. Removal of the ROPS severely increases the risk of injury or death in a rollover or any other accident.

12.5 Shoulder Guards (as equipped)

The ROXOR is equipped with operator and passenger shoulder guards. They are designed to help restrain the entire body and also help the operator and passenger to remain inside the cockpit.

WARNING

The shoulder guards (as equipped) are an integral part of the safety system and must not be removed. Removal of the shoulder guards severely increases the risk of injury or death in a rollover or any other accident.

12.6 Side Nets / Doors

The ROXOR is equipped with operator and passenger side nets or doors. They are designed to help arms and legs remain inside the cockpit. Side nets or doors can also help keep brush and debris out of the cockpit.

WARNING

The side nets or doors are an integral part of the safety system and must not be removed. Removal of these severely increases the risk of injury or death in a rollover or any other accident.

12.7 Passenger Handhold

The ROXOR is equipped with a hand hold on the passenger side of the cockpit. It is designed to help keep limbs inside the cockpit.

WARNING

The passenger handhold is an integral part of the safety system and must not be removed. Removal of the passenger handhold severely increases the risk of injury or death in a rollover or any other accident.

12.8 12 Volt Power Outlet



The ROXOR is equipped with one 12 volt power outlet, located on the right side of the dash panel.

12.9 Storage Compartments

The ROXOR is equipped with two lockable storage compartments, one under each seat.

NOTICE

Neither of these two lockable storage compartments is waterproof. All electronics or other valuables stored in these compartments should be adequately protected by other means.

12.10 Cup Bottle Holders

Two cup holders are located on the floor between the seats.

12.11 Rear Cargo Area

The ROXOR is equipped with a rear cargo area located behind the rear most passenger seat. The rear cargo area may be used for hauling various types of cargo. Properly secure all loads in the rear cargo area using the factory supplied cargo tie downs only. To help reduce the risk of loss of control, or loss of load use the cargo area in accordance with section 19 Moving Loads and Doing Work.

WARNING

Never carry any passengers in the rear cargo area. Passengers in this area cannot be properly restrained and could be ejected, resulting in severe injury or death.

12.12 Tailgate

The ROXOR is equipped with a swing style tailgate. The tailgate is designed to ease loading the rear cargo area and also carrying an optional spare tire. Always close the tailgate before operating to prevent damage to the tailgate, lock mechanism and/or cargo.

WARNING

Failure to close the tailgate before operating could result in the lose of cargo loads, severely increasing the risk of injury or death.

12.13 Fuel Reservoir Cap

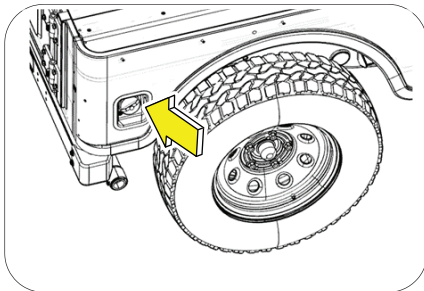

The fuel reservoir cap is located on the right side behind the rear wheel.

Refer to 14.1 Fuel Requirements or 14.2 Fueling Procedure for more on fuel related information.

13 Electrical Distribution

Power Distribution Center – This component is located in the engine bay on the driver side. The Power Distribution Center cover contains a similar graphic to the one shown here for convenience.

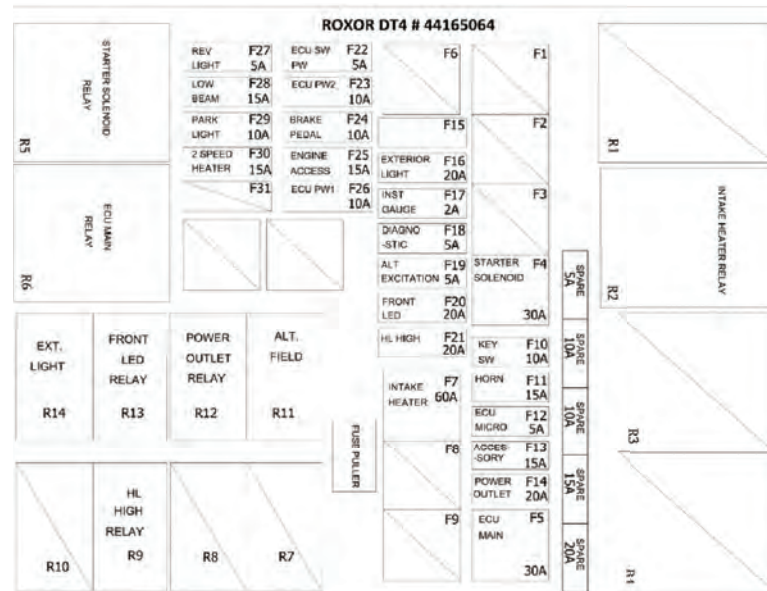
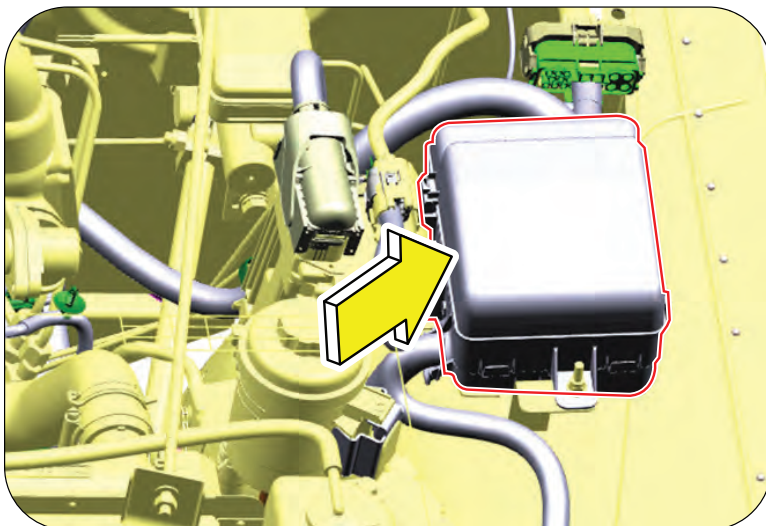



Power Distribution Center		
Fuse No.	Circuit	Fuse Rating
F1 to F3	Empty	-
F4	Starter Solenoid	30A
F5	ECU Main	30A
F6	Empty	-
F7	Intake Heater	60A
F8 – F9	Empty	-
F10	Ignition Key Switch	10A
F11	Horn	15A
F12	ECU Micro	5A
F13	Accessory	15A
F14	Power Outlet	20A
F15	Empty	-
F16	Exterior Lighting	20A
F17	Instrument Gauge	2A
F18	Diagnostic Port	5A
F19	Alternator Field Excitation	5A

Power Distribution Center		
Fuse No.	Circuit	Fuse Rating
F20	LED Lightbar Accessory	20A
F21	High Beam Headlight	20A
F22	ECU Switched Power	5A
F23	ECU Power 2	10A
F24	Brake Light & Seat Belt Indicator	10A
F25	Engine Accessory	15A
F26	ECU Power1	10A
F27	Reverse Light	5A
F28	Low Beam Headlight	15A
F29	Parking Light	10A
F30	2 Speed Heater	15A
F31	Empty	-



Relay No.	Circuit
R1	Empty
R2	Intake Heater
R3 - R4	Empty
R5	Starter Solenoid
R6	ECU Main
R7-R8	Empty
R9	High Beam Headlight
R10	Empty
R11	Alternator Field Excitation
R12	Power Outlet
R13	LED Lightbar Accessory
R14	Exterior Lighting

14 Fuel (Diesel)

14.1 Fuel Requirements

The EPA has adopted multiple tiers of emission standards to reduce emissions from non-road diesel engines. From 2007 to 2014, Low Sulfur Diesel (LSD) fuel and Ultra Low Sulfur Diesel (ULSD) fuel was phased in for non-road, locomotive, and marine (NRLM) diesel fuel. This off-road diesel requires ULSD rated fuel that meets the EPA Nonroad Diesel Fuel Standards (<https://www.epa.gov/diesel-fuel-standards>).

Damages, performance or service concerns determined to be caused by the use of non-approved fuels, including any grade of gasoline or form of bio-diesel fuel not meeting the specifications outlined above are not considered to be defects in material or factory workmanship and are not covered under the limited warranty or EPA limited warranty.

CAUTION

Do not put gasoline in a diesel equipped ROXOR. Gasoline will prematurely ignite in a diesel engine which can lead to engine damage, voiding all of your warranty coverage. Gasoline contamination can also damage the fuel pump and diesel injectors, which would also void all of your warranty coverage.

14.2 Fueling Procedure

1. Stop the engine.
2. Only fill the fuel tank in a well ventilated area.
3. Have the operator and all passengers get out of the ROXOR.
4. Unscrew fuel reservoir cap slowly by turning it counterclockwise to remove it.
5. Insert the fuel spout into the fuel filler neck.
6. Pour fuel slowly so that air can escape from the tank and prevent fuel flow back and spills.
7. Stop filling before the fuel reaches the bottom of filler neck. Do not overfill or spill fuel.
8. Fully tighten fuel reservoir cap by turning it clockwise until a ratchet noise is heard.

WARNING

All fuel handling must take place in a well-ventilated area. Avoid heat, flames and other sources of ignition, avoid inhalation of vapors and contact with skin and eyes, do not siphon diesel fuel by mouth, never fill a fuel container inside the ROXOR as the interior surfaces are coated, acting as an insulator and allowing static electricity to build up, help guard against static discharges by always filling approved containers on the ground, do not allow anyone to remain in the ROXOR while fueling, an occupant may not be able to leave the area quickly in an emergency, failure to follow these warnings may result in severe injury or death.

15 Break in Period

15.1 Operation During Break In

A break-in period of 10 operating hours or 300 mi (480 km) is required for this vehicle. MAgNA recommends that the engine oil and filter be replaced after this break-in period has been completed.

During the break-in period it is best to avoid pressing the accelerator pedal beyond 3/4 of its full stroke. Avoid extended hard accelerations like those required for hill climbing. Avoid extended periods at steady cruising speeds, it is best to vary your speed as much as possible during this period. Brief accelerations and speed variations contribute to a good break-in.

During the break-in period you should also shift the transfer case between 2WD and 4WD High range at low speeds (1-5 mph). This also contributes to a good break-in and will familiarize you with the effort required to perform this operation while moving.

NOTICE

Bring the ROXOR to a complete stop with engine running before shifting the transfer case into 4WD Low Range to prevent gear damage and ease engagement. The ROXOR can be shifted between 2WD and 4WD High ranges at any speed.

15.2 Tips for Maximizing Durability

Riding style and conditions have a direct impact on durability. MAgNA highly recommends you not maintain wide open pedal (WOP) for more than two (2) minutes. After two (2) minutes at WOP, partially release the accelerator pedal and allow the engine and drivetrain to cool down.

NOTICE

This is particularly important in high ambient temperatures above 86° F (30° C), heavy passengers and/or cargo loads, heavy drags like soft sand and/or hill climbing and mud bogs.



16 Avoiding Accidents

Operators must be responsible and use care to avoid rollovers, collisions, and accidents. The ROXOR is designed and manufactured for off-road use only. The ROXOR does not conform to Federal Motor Vehicle Safety Standards (FMVSS) and operation on public streets, roads, or highways is illegal and increases the risk of an accident involving other vehicles.

Avoid rollovers. The ROXOR handles very different from other vehicles. A rollover can occur quickly with sudden changes in terrain. Holes, humps, obstacles and soft ground can result in the ROXOR becoming unstable. Aggressive driving habits can also result in rollovers and loss of control, even on flat terrain. Therefore, it is particularly important to fasten seat belts and side nets, secure the doors (if equipped) and wear an approved helmet and riding gear. Never try to stop a rollover using your arms or legs. Never put any part of your body outside of the ROXOR for any reason. If you think or feel the ROXOR may tip or roll, reduce your risk of injury by keeping a firm grip on the steering wheel or handholds and brace yourself. Keep feet firmly planted on the floor.

Avoid driving across a slope when possible, instead, drive straight up and down inclines rather than across them. If driving across a slope is unavoidable, use extreme caution. If you feel the ROXOR start to roll over steer downhill if possible.

Avoid speeding. The ROXOR can reach high speeds, particularly in challenging off-road conditions. At higher speeds there is an increased risk of losing control, an increased risk of collision and an increased risk of injury or death. Always drive at a speed that matches the terrain, visibility and your experience. Slow down on

uneven terrain and allow more distance to stop. The ROXOR also handles differently when carrying a load or pulling a trailer. Reduce speed and follow instructions in this Operator's Guide for carrying a load or pulling a trailer.

Avoid paved surfaces. If you must drive on paved surfaces, take it slow and use care when turning. Abrupt steering inputs and hard acceleration and braking, even at slow speeds can result in an accident. Never attempt to do donuts, skids, slides, fishtails, jumps, or other stunts with the ROXOR.

WARNING

The ROXOR does not conform to Federal Motor Vehicle Safety Standards (FMVSS) or US EPA on-highway exhaust emissions regulations. And as such, does not have important features and equipment that on road vehicles have driving on public streets, roads or highways without these important features and equipment can lead to severe injury, including death.



17 OFF-Road Operation

Driving off-road or more specifically on unsurfaced roads or two tracks, made up of materials like sand, gravel, mud, snow, rocks, and other natural terrain is hazardous and can be dangerous. Any terrain which is not specially prepared to carry vehicles presents an inherent danger. An operator who ventures off-road should always exercise the utmost care in selecting the safest path and keeping a close eye on the terrain ahead of them. This Mahindra ROXOR Offroad Side x Side should never be operated by someone who is not very familiar with how to control it.

Persons taking part in this activity have sometimes been met with criticism for the environmental damage incurred by their vehicles. Please be courteous and limit your use of the ROXOR to private property or areas specifically designated for off-road activities. Always practice the "Leave no Trace" and "Tread Lightly! ®" principles and ethics of outdoor conservation. Always respect nature and the rights of others to enjoy it.



18 General Driving Techniques

18.1 Driving Tips

- Stay alert to changing terrain conditions as slopes and obstacles can decrease stability.
- Proceed slowly when entering unfamiliar terrain, if in doubt, back out.
- Power and traction, not speed, are most important in driving offroad.
- Keeping both hands on the steering wheel is the best way to maintain control.
- Make every attempt to avoid obstacles that could enter the cockpit area and hit you or your passengers.
- Never operate the ROXOR if the controls do not function normally, instead take it to a ROXOR authorized dealer.

18.2 Driving in Reverse

- Choosing a safe place to turn around is always preferred whenever possible.
- Be aware that abrupt steering inputs while driving in reverse can increase the risk of a roll over.
- When operating in reverse, check that the path behind the ROXOR is free of people and/or obstacles.
- When safe, proceed with care and caution, go slowly and avoid sharp turns.
- Always maintain a level of alertness to your blind spots when driving in reverse.
- Pay attention to blind spots. When it is safe to proceed in reverse, go slowly and avoid sharp turns.

WARNING

When driving downhill in reverse, gravity can increase your speed above a safe level. Always use engine and gears to slow descent rate and prevent over heating the brakes.



18.3 Driving in or on Slippery Surfaces

- Slow down and avoid abrupt steering inputs to prevent sliding and roll overs.
- Be aware that it may take longer to stop your ROXOR, be cautious and avoid locking the brakes.
- Hard accelerations on these surfaces may result in loose material to be thrown rearwards into the path of others.
- Hard accelerations may result in tire spin, the ROXOR to sink, eventually becoming stuck.
- Use lower gears and/or 4WD Low Range to help prevent tire spin.

18.4 Driving in or on Sand

- Sand and sand dune riding is a unique experience. On sand dunes it is advisable to equip the ROXOR with an antenna type safety flag.
- When riding on sand dunes, proceed cautiously if you see another safety flag and remember vehicles can approach you from any direction.
- Slow down and avoid abrupt steering inputs to prevent sliding and roll overs, especially on hills.
- Hard accelerations on these surfaces may result in loose material to be thrown rearwards into the path of others
- Hard accelerations may result in tire spin, the ROXOR to sink, eventually becoming stuck.
- Use lower gears and/or 4WD Low Range to help prevent tire spin.



18.5 Driving in or on Snow or Ice

- Be aware that snow cover may hide obstacles like holes and logs that can affect the ROXOR's traction and stability.
- Before driving on frozen waterways, check the ice thickness to ensure it will safely support the weight of the ROXOR.
- Always keep controls, pedals and floor board free of snow and ice to prevent loss of control.
- Slow down and avoid abrupt steering and throttle inputs to prevent sliding and roll overs.
- Use lower gears and/or 4WD Low Range to help prevent tire spin.
- Be aware that it may take longer to stop your ROXOR, be cautious and avoid locking the brakes.
- To prevent snow and ice accumulation on brake pads and discs, which may affect the response time of the braking system, periodically apply the brakes.

18.6 Driving on Hills and Slopes

- Avoid parking on slopes, if unavoidable, put the shift lever in gear, set the parking brake and block the tires.
- Approach the tops of hills with caution to avoid a collision with vehicles coming from the other direction.
- It may be necessary to check the terrain conditions on the opposite side of a hill before proceeding because the ROXOR can ascend steeper slopes than it can descend.
- Never attempt to turn the ROXOR around on hills and slopes.
- Use lower gears and/or 4WD Low Range to help prevent tire spin.
- While the ROXOR has extremely good traction for ascending steep slopes, it is possible to tip over before losing traction.
- Always keep the transmission in gear when descending hills and slopes and choose a gear that will help control your descent.

18.7 Side Hilling

- Side hilling or driving across a slope should be avoided whenever possible.
- Use extreme caution and avoid obstacles that can raise the uphill side of the vehicle, this increases the potential for a roll over.
- Be aware of slippery or unfirm surfaces which can cause uncontrollable slides and steer downhill to reduce the chance of a roll over.

WARNING

Be aware that cargo can change the center of gravity affecting the vehicles stability and increasing the risk of a roll over. Cargo can also shift causing the pedals to become stuck thereby causing a loss of control.

18.8 Drop Offs

- The ROXOR is not designed to traverse a sheer downward slope, cliff or drop off.
- If you encounter a sheer downward slope, cliff or drop off, back up and select a different route.
- If the front or rear wheels are driven off this type of terrain it will most likely stop moving or roll over.

DANGER

Attempting to negotiate drop offs as described above may lead to severe injury or death.

18.9 Crossing Obstacles

- It is best to avoid obstacles whenever possible.
- Operator/ Passengers should grip steering wheel/ handhold firmly and keep feet on the floor during all crossings.
- Never try to cross obstacles that are higher than the ground clearance (9") of the ROXOR.
- Adjust your speed without losing momentum and try to approach obstacles head on.
- Be aware that obstacles can be slippery and even move while crossing them.

CAUTION

Under rough trail conditions or when crossing an obstacle, the steering wheel could suddenly jerk in one direction or the other. Grip the steering wheel with both hands, without having thumbs wrapped around the steering wheel. Hand and/ or wrist injuries may occur if the thumbs are wrapped around the steering wheel.



18.10 Crossing Shallow Water

- Water crossings present a unique set of hazards, hidden obstacles, holes and changes in water depth can cause a loss of traction, even float the vehicle and cause it to topple over.
- The water depth for this vehicle should not exceed 12 in. (30 cm) or roughly the center point of the standard OEM wheels.
- Check the water depth, and strength and direction of current, before you attempt to make a water crossing.
- Cross at right angles at a point where the stream bed is straight and uniform.
- Never enter the water at high speed, proceed slowly and cautiously watching for obstacles underneath the surface.
- Water will affect the braking ability of your vehicle, always apply the brakes several times after leaving the water to dry and test them.
- In the event the ROXOR is submerged further than recommended depths, all fluids and lubricants should be checked and changed as needed.

NOTICE

It is your responsibility to check your local laws related to water crossings. Some rivers and streams are protected from activities like this.

18.11 Crossing Public Streets, Roads, or Highways

Obey all sign and traffic signals.

Do not proceed if complete visibility in both directions is hindered. Choose an exit point on other side of road, then wait for oncoming traffic to pass.

Drive in a straight line, do not make sharp turns or sudden accelerations.

18.12 Driving on Pavement

The ROXOR is designed and manufactured for off road use only.

The ROXOR is not equipped or legal to operate on public streets, roads or highways.

If you must drive on pavement, turn gradually, go slowly, and avoid abrupt acceleration and braking.

WARNING

The ROXOR does not conform to Federal Motor Vehicle Safety Standards (FMVSS) or US EPA on-highway exhaust emissions regulations. And as such, does not have important features and equipment that on road vehicles have driving on public streets, roads or highways without these important features and equipment can lead to severe injury, including death.

18.13 Group and Distance Riding

- Driving off-road in a group of vehicles can be a lot of fun, it can also be very dangerous if you do not trust the judgment of those around you.
- Never use the ROXOR or group ride when you, or members of your group, have been consuming or are under the influence of drugs or alcohol, or when feeling tired or ill. These effectively slow your reaction time and impair judgment.
- Respect the rights, skills and limitations of others by keeping a safe distance and yielding the right of way to other riders.
- When driving off-road, stay to the right of the trail especially around corners and over hills, do not zigzag, and do not assume no other vehicles are on the trail.
- Check the local laws where you plan to ride. The ROXOR may be prohibited from sharing snowmobile trails, cross country ski trails, equestrian trails, hiking trails, mountain bike trails or other public parks and trails.
- Always be prepared to stop quickly and/or pull off the side of the trail if another vehicle appears in front of you.
- Always tell someone where you are planning to go and when they should expect you back.
- Always consider bringing additional clothes, tools, emergency equipment and a first aid kit, and checking the local weather report.
- Find out where you can get additional fuel.

WARNING

When group riding, be aware that others in your group may not have safety equipment, like turn signals. Always keep a safe distance between vehicles.

18.14 Environment

Always practice the "Leave no Trace" and "Tread Lightly! ®" principles and ethics of outdoor conservation. Always respect nature and the rights of others to enjoy it.

Always get the permission of landowners before riding on private land, respect property lines, crops and farm animals.

Never drive your ROXOR in environmentally sensitive areas, through wetlands, muskeg or tall grass and do not pollute rivers, streams and lakes.

Never use your ROXOR to chase wildlife as they can die from exhaustion. In many areas this activity is illegal.

It is possible to encounter wildlife while driving off-road, stop and observe quietly from a distance.

The ROXOR can develop exhaust and/or other engine hot spots on long rides, debris build up in these areas resulting in wildfires if this debris ignites and falls off. Periodically check these areas before, during and after your ride.



19 Moving Loads and Doing Work

19.1 Working with Your ROXOR

A variety of accessories are available from your ROXOR authorized dealer that can aid you in your work efforts. Contact your local dealer to learn more about the cost and availability of these accessories. Be sure to read and follow the instructions, warnings and limitations of those accessories before using them to do work. Also familiarize yourself with the weight and load limits of the Mahindra ROXOR Offroad Side x Side to avoid having a limited warranty claim denied due to improper use.

WARNING

Every hauling, pulling or winching situation has the potential for personal injury or death. Make sure anyone using the ROXOR to do work reads and comprehends the safety instructions outlined in this section.

19.2 Weight and Load Limits

Gross Vehicle Weight Rating (GVWR)	4600 lbs	2087 kg
Base Dry Weight	2988 lbs.	1355 kg
Maximum Vehicle Load Capacity	1525 lbs.	692 kg
Maximum Towing Capacity	3,500 lbs.	1,588 kg
Maximum Tongue Weight	350 lbs.	159 kg

19.3 Loading the Rear Cargo Area

When loading cargo into the ROXOR, position the cargo toward the front and center of the cargo area, and as low as possible. Verify the tailgate is latched before operating.

High heavy loads can change the center of gravity of the ROXOR increasing the potential for a roll over. Be aware that carrying liquid loads can add an additional hazard. Avoid carrying loads that block your ability to see or increase your blind spots.

Use only the tie downs provided to secure a load in the rear cargo area, never secure a load to the Rollover Protective Structure (ROPS) except at the two approved tie down points provided, one at the base of each center side support.

WARNING

Loads that are not properly secured can become projectiles when stopping, turning or in an accident causing damage to the ROXOR, as well as severe injury and death to the operator, passengers and bystanders.

NOTICE

Never exceed the Gross Vehicle Weight Rating (including passengers, cargo and vehicle weight)

19.4 Carrying Loads

Be aware that handling and stability will be affected when carrying loads. Slow down, turn gradually and avoid hills and rough terrain. Also, be cautious coming to a stop as the braking distance of the ROXOR may increase with a load, especially on down hill slopes. Never exceed the maximum vehicle load capacity as listed. Bear in mind that the weight of the operator and passengers, any cargo, all accessories added to the base ROXOR and trailer tongue weight are all included in this maximum vehicle load capacity value of 1525 lbs

WARNING

Loads that are not properly secured can become projectiles when stopping, turning or in an accident causing damage to the ROXOR, as well as severe injury and death to the operator, passengers and bystanders.

WARNING

Be aware that cargo can change the center of gravity affecting the vehicles stability and increasing the risk of a roll over. Cargo can also shift causing the pedals to become stuck thereby causing a loss of control.

19.5 Hauling and Pulling Loads

When hauling a load or pulling a trailer, respect the maximum vehicle load capacity of the ROXOR. Only use the trailer hitch (if installed) or winch (if installed) to pull a load. Never try to pull the ROXOR by wrapping chains or straps around its axles, cargo tie downs or ROPS. Know the Working Load Limit (WLL) of the strap, chain or cable you are using. Never stand in the recoil or snap back area, this is the area that the strap, chain or cable could reach when "snapping back" if a failure (break) occurs.

When using straps, chains or cables for pulling, cautiously remove any slack without jerking the load. A sudden jerk on the load can damage the chain, cable and/or vehicles. Be sure to maintain tension on the load throughout the hauling process.

When pulling another vehicle, the previously mentioned principles still apply. This activity also requires someone to control the vehicle being pulled. Slow down and use hand signals to communicate if necessary and allow more distance for stopping. Never attempt to pull another vehicle without an operator controlling it.

Before hauling or pulling a load or a trailer be sure to read the manufacturer's instructions and warning. Never exceed the manufacturer's maximum load capacities. Always make sure the trailer load is evenly distributed and secured. An evenly balanced trailer is easier to control. Make sure there is sufficient tongue weight to prevent a loss of traction at the rear wheels.



WARNING

It is your responsibility to make sure the hitch on the ROXOR and the hitch on the trailer are compatible. Never exceed the manufacturer's maximum load capacity of the trailer, hitch or the capacity and limitations of the ROXOR. The trailer and/or hitch could fail under the excess load and break away from the ROXOR resulting in personal injury or death.

WARNING

Driving off-road while pulling a trailer substantially increases the risk of a roll over, especially on uneven terrain and slopes. Be aware that if the trailer is involved in a rollover, it may force the ROXOR to follow, resulting in personal injury or death.

20 Transporting

20.1 Trailering

If your ROXOR needs to be transported, use the images provided here to help properly secure the ROXOR to the trailer. At a minimum, the ROXOR should be secured in this manner at all four corners, with suitable straps and/or chains, and crossed as shown to help prevent lateral shifting during transport.

For proper trailer sizing and capacity questions refer to section **26.2 Vehicle Specifications.**

Straps around axles

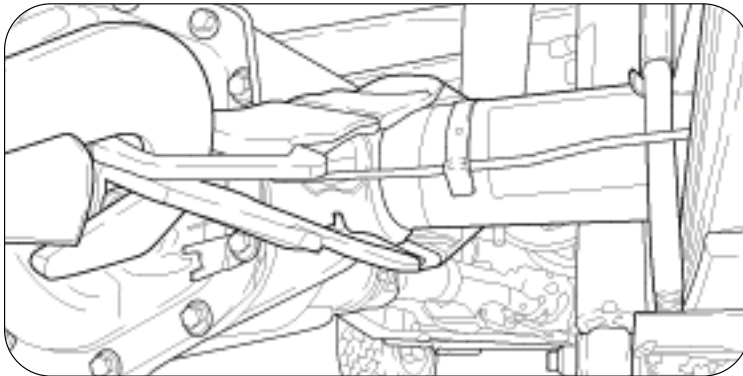

Straps to trailer tie downs

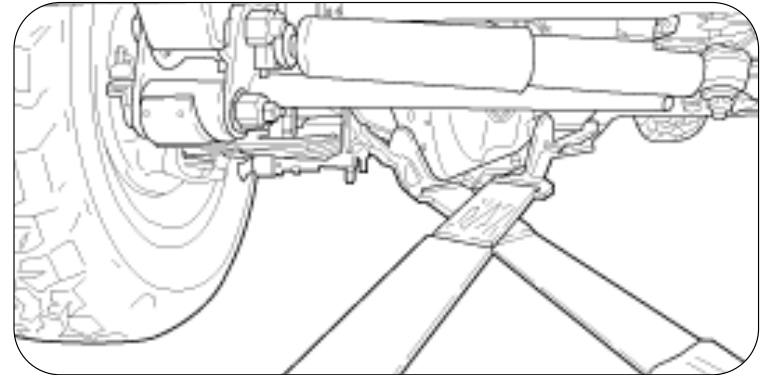

WARNING

Use extreme caution when securing the axles, do not wrap straps or chains completely around the axles, so as not to damage the brake lines resulting in severe injury or death.

WARNING

Make sure no loose objects are present inside the ROXOR or in the rear cargo area during transportation as they can be lost or worse become projectiles. Never trailer the ROXOR backwards, always trailer it facing forward. The windshield (if equipped) could break away, be lost or worse become a projectile resulting in severe injury or death.



20.2 Towing

For flat/tow bar towing and dolly towing the ROXOR follow the instructions listed here. Check with your ROXOR authorized dealer for any updates on this subject. Be advised that Front Locking Hubs are required for this activity. (Conversion Kit Sold Separately)

WARNING

Follow the manufacturer's instructions for installation and use of all third party towing devices. Only attach towing device brackets to the 4 bolts (per side) that attach the front bumper. Secure or remove all loose contents in your ROXOR before attempting to tow it. Failure to follow these warnings may result in severe injury or death.

NOTICE

The preferred method for extended towing the ROXOR is to remove the front and rear propeller shafts.

NOTICE

Check your local regulations to determine if the towed vehicle needs to be licensed and plated. Some states may also require brake actuation systems.

Towing Preparation Procedure:

1. Verify tires are inflated to 28 psi.
2. Verify vehicle alignment meets manufacturers specification.

3. Verify both differentials, the transfer case and transmission fluid levels are at their recommended levels.
4. Verify all grease locations are properly lubricated.
5. Do not secure the steering wheel, it must be free to rotate for vehicle to track correctly.
6. Use magnetic safety /tail lights attached to the rear of the ROXOR in tow.

Manual Transmission Towing Procedure:

1. Position the ROXOR behind the tow vehicle, facing forward on a level surface.
2. Securely attach the ROXOR to the tow vehicle.
3. On the ROXOR disengage /unlock the Manual Locking Front Hubs per manufacturer's instructions.
4. Shift the ROXOR transfer case to N (Neutral).
5. Shift the ROXOR transmission into 1st gear.
6. Begin towing and limit tow speed to 55 mph.
7. Do not attempt to back up.

Start towing slowly and verify the ROXOR is tracking correctly, check the hubs for heat buildup after driving for 25 miles and then every 100 miles after that.

21 Lifting and Supporting

Place the ROXOR on a flat, non-slippery surface. For hydraulic jack lifting, place the hydraulic jack under the center of the axle only. Once lifted, support the ROXOR with suitable jack stands positioned under the right and left frame rails. If lifting just the front, or just the back, be sure to block the opposite wheels using rocks, logs or wheel chocks.

For hoist lifting, only use the two front locations and the two rear locations shown here.

Front Lifting Location

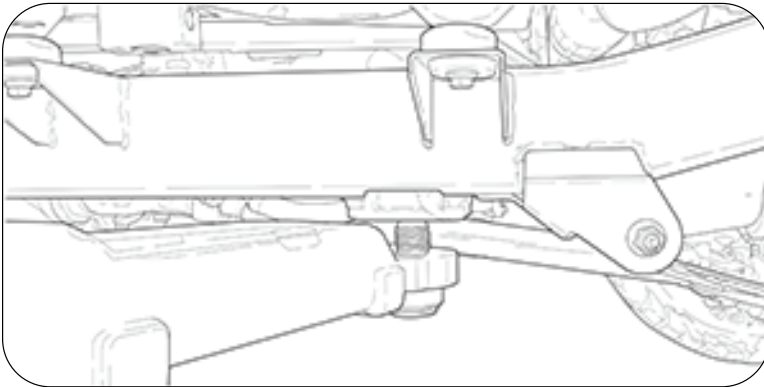

Rear Lifting Location

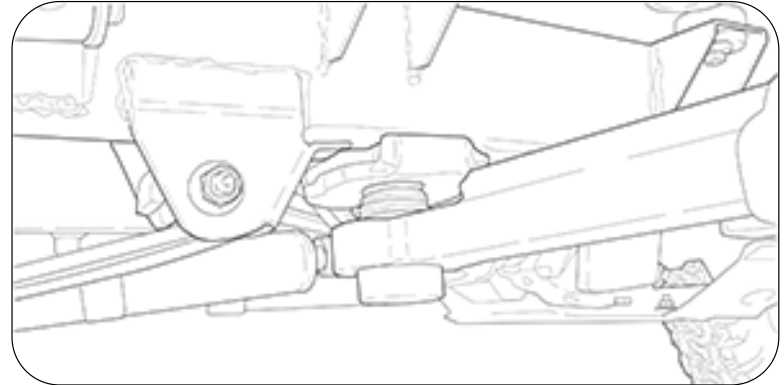

WARNING

Verify the unit is stable on the hoist before raising all the way up and going underneath it to help prevent an accident resulting in severe injury or death.



22 Maintenance

Keep your ROXOR in safe operating condition by performing the regular maintenance as scheduled. Refer to section **22.2 Scheduled Maintenance Chart**.

As required by the EPA we must inform you that a repair shop or person of the owner's choosing may maintain, replace, or repair emission control devices and systems. You are not required to purchase components or services from a ROXOR authorized dealer, although a ROXOR authorized dealer has an in-depth technical knowledge and tools to service the Mahindra ROXOR Offroad Side x Side.

The emission related limited warranty is not conditioned on the use of a ROXOR authorized dealer or any other establishment with which MAgNA has a commercial relationship. For more information, refer to section **28.1 U. S. EPA Emission-Related Limited Warranty (Canada Excluded)**. Proper maintenance is the owner's responsibility. A warranty claim may be denied if, among other things, the owner or operator caused the problem through improper maintenance or use. You must follow the instructions for fuel requirements in section **14.1 Fuel Requirements**.

WARNING

Failure to properly maintain the vehicle according to the maintenance schedule and procedures provided in this section can make the ROXOR unsafe to operate resulting in severe injury or death.

22.1 Severe Dusty Conditions

Air filter maintenance should be adjusted according to riding conditions. Air filter maintenance must be increased in frequency in the following dusty conditions:

- Riding on dry sand.
- Riding on dry dirt covered surfaces.
- Riding on dry gravel roads or similar conditions.

CAUTION

Riding in a group in these conditions would increase the air filter maintenance even more.



22.2 Scheduled Maintenance Chart

Item	Maintenance Interval (Use interval that occurs first for each item)			Maintenance Procedure	
	Hours of Operation	Calendar	Miles (Km)		
<p>A = It is recommended that the maintenance procedure be performed by an Authorized Mahindra Dealer/Service facility.</p> <p>S = For a ROXOR subjected to Severe use, perform the maintenance procedure more frequently than the recommended intervals.</p>					
A	Break In	10 Hrs		300 (480)	<ul style="list-style-type: none"> • Replace oil and oil filter • Check all fluid levels
-	Fuel/Water Separator	10 Hrs		300 (480)	<ul style="list-style-type: none"> • Drain weekly (as used)
A	Fuel Filter	50 Hrs	6 M	1,500 (2,500)	<p>Normal use with high quality fuel:</p> <ul style="list-style-type: none"> • Replace Fuel Filter
S	Engine Oil and Filter	50 Hrs	6 M	1,500 (2,500)	<ul style="list-style-type: none"> • Replace oil, oil filter, and copper washer
S	Air Intake System; Air Cleaner / Filter	100 Hrs	-	3,000 (5,000)	<ul style="list-style-type: none"> • Inspect for debris and/or oil. • Clean or replace
-	Battery	100 Hrs	12 M	3,000 (5,000)	<ul style="list-style-type: none"> • Inspect terminals for corrosion or loose connectors. Clean and test
-	Propeller Shaft	100 Hrs	12 M	3,000 (5,000)	<ul style="list-style-type: none"> • Lubricate
-	Exhaust Pipe	100 Hrs	12 M	3,000 (5,000)	<ul style="list-style-type: none"> • Inspect for corrosion or damage. Repair as needed



Item	Maintenance Interval (Use interval that occurs first for each item)			Maintenance Procedure	
	Hours of Operation	Calendar	Miles (Km)		
<p>A = It is recommended that the maintenance procedure be performed by an Authorized Mahindra Dealer/Service facility.</p> <p>S = For a ROXOR subjected to Severe use, perform the maintenance procedure more frequently than the recommended intervals.</p>					
S	Radiator and Cooling Fan(s)	100 Hrs	12 M	3,000 (5,000)	<ul style="list-style-type: none"> Inspect radiator for damaged fins or debris obstructing airflow. Repair or replace, as needed Inspect fan for damage. Repair or replace, as needed Clean external surfaces Pressure test the system
A	Shift Linkage	100 Hrs	12 M	3,000 (5,000)	<ul style="list-style-type: none"> Lubricate and adjust as needed
S	Suspension	100 Hrs	12 M	3,000 (5,000)	<ul style="list-style-type: none"> Lubricate leaf spring pivots
S	Turbo Oil Lines	100 Hrs	-	3,000 (5,000)	<ul style="list-style-type: none"> Inspect for leaks or loose fittings. Repair as needed
A	Wheel Bearings	100 Hrs	12 M	3,000 (5,000)	<ul style="list-style-type: none"> Inspect bearings for wear and repack. Replace as needed
-	Wiring	100 Hrs	12 M	3,000 (5,000)	<ul style="list-style-type: none"> Inspect for wear, loose or worn connections. Repair as required Apply dielectric grease to connectors subjected to water, mud, etc



Item	Maintenance Interval (Use interval that occurs first for each item)			Maintenance Procedure	
	Hours of Operation	Calendar	Miles (Km)		
<p>A = It is recommended that the maintenance procedure be performed by an Authorized Mahindra Dealer/Service facility.</p> <p>S = For a ROXOR subjected to Severe use, perform the maintenance procedure more frequently than the recommended intervals.</p>					
-	Fuel System	100 Hrs	12 M	3,000 (5,000)	<ul style="list-style-type: none"> Inspect lines and fittings for leaks and abrasions. Repair or replace as needed
A/S	Brakes	100 Hrs	12 M	3,000 (5,000)	<ul style="list-style-type: none"> Clean and inspect. Replace as needed
S	Tire Rotation	-	-	3,000 (5,000)	<ul style="list-style-type: none"> See Section 23.17 for rotational pattern
A	Clutch Fluid	300 Hrs	36 M	9,000 (15,000)	<ul style="list-style-type: none"> Replace fluid
S	Axle Gear Lube	300 Hrs	36 M	9,000 (15,000)	<ul style="list-style-type: none"> Replace fluid
S	Power Steering Fluid	300 Hrs	36 M	9,000 (15,000)	<ul style="list-style-type: none"> Replace fluid.
S	Transfer Case Oil	300 Hrs	36 M	9,000 (15,000)	<ul style="list-style-type: none"> Replace fluid
S	Transmission Oil	300 Hrs	36 M	9,000 (15,000)	<ul style="list-style-type: none"> Replace fluid
-	Spark Arrester	300 Hrs	36 M	9,000 (15,000)	<ul style="list-style-type: none"> Clean
A	Suspension Bushings	300 Hrs	36 M	9,000 (15,000)	<ul style="list-style-type: none"> Inspect for wear or noise. Replace as needed
S	Coolant	-	36 M	-	<ul style="list-style-type: none"> Replace fluid
A	Accessory Belt(s)	-	60 M	-	<ul style="list-style-type: none"> Inspect for wear or noise and proper tension. Adjust or Replace as needed



Item	Maintenance Interval (Use interval that occurs first for each item)			Maintenance Procedure	
	Hours of Operation	Calendar	Miles (Km)		
<p>A = It is recommended that the maintenance procedure be performed by an Authorized Mahindra Dealer/Service facility.</p> <p>S = For a ROXOR subjected to Severe use, perform the maintenance procedure more frequently than the recommended intervals.</p>					
S	Engine Mounts	-	60 M	-	<ul style="list-style-type: none"> Inspect for wear or damage. Replace as needed
A	Valve Timing / Clearance	-	-	-	<ul style="list-style-type: none"> n/a - self - adjusting hydraulic lash
A/S	Auxiliary / Parking Brake	As needed			<ul style="list-style-type: none"> Lubricate and adjust as needed
-	Headlight Aim	As needed			<ul style="list-style-type: none"> Adjust as needed
A	Wheel Alignment; Toe Adjustment	As needed			<ul style="list-style-type: none"> Adjust as needed. Align whenever parts are replaced during routine maintenance

23 Maintenance Procedures

23.1 Maintenance Tips and Precautions

Observe the following tips and precautions when performing maintenance on the ROXOR.

- Always wear eye protection and gloves.
- Stay clear of rotating parts when engine is running.
- Stay clear of hot parts, before during and after maintenance.
- Avoid repeated contact with fluids.
- Do not allow fuel, coolant and other fluids to spill over electrical and hot parts
- Before removing parts for maintenance, it is best to clean the outer surface of the parts being replaced.
- Care must be taken when handling the air intake system components. Never lift by using their hoses or pipes.
- Ensure that hoses and lines are oriented in their correct position before tightening the clamps.
- Hoses and lines must not be subjected to any twists or stress.
- Ensure that all clips and supports are replaced.
- Never run the engine in an enclosed area. Exhaust contains carbon monoxide which can cause loss of consciousness or death in a very short time.
- Check to make sure the engine is off and parking brake set before jacking up the vehicle.

- Never go under the vehicle while it is inclined without proper bracing (approved jack stands).

23.2 Clean Spark Arrester

Do not perform service on the spark arrester while the system is hot. Exhaust systems can reach extreme temperatures. Allow components to cool sufficiently before proceeding. Remove any combustible materials from around the spark arrester.

1. Place the transmission in Neutral and set the Parking Brake.
2. Remove the Retaining Screw and remove the Spark Arrester from the end of the Tailpipe. (Refer the below image)

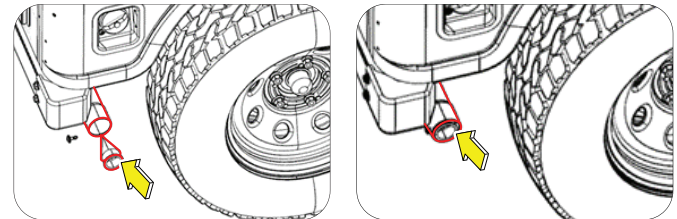

3. Use a Non-Synthetic brush to clean the arrestor screen. A Synthetic brush may melt if the temperature of components exceeds the melting point for the Synthetic material.
4. If necessary, blow debris from the screen with compressed air and/or use a solvent/degreaser such as carburetor cleaner
5. Inspect the screen for wear and damage. Replace a worn or damaged screen.
6. Reinstall the Spark Arrestor.
7. Torque the Retaining Screw to 5-7ft. lbs. (7-9 Nm).

23.3 Clean and Inspect Brakes

Brake maintenance is important, not only for the obvious safety reasons, but also to help preserve the wear components.

The brake system consists of six main components that should be inspected and/ or cleaned. They are the brake pads, rotors, calipers, drums, brake lines, and master cylinder.

The wheels and tires should be removed to perform this procedure properly. Refer to section 21 Lifting and Supporting for instruction.

1. Check the brake system for fluid leaks.
2. Check the brake pedal for excessive travel or a spongy feel.
3. Clean and inspect the pads for wear, damage and looseness.
4. Clean and inspect the brake discs and drums for signs of cracks, excessive wear or corrosion, warping or other damage.
5. Clean any grease using an approved brake cleaner or alcohol.
6. Inspect parking brake cable for free movement. Clean and lubricate as necessary.

WARNING

Do not apply rust inhibiting penetrating oil or other petroleum based products to brake discs and drums. This could render your braking system inoperable resulting in severe injury or death.

NOTICE

Generally, there should be at least a 1/4" (6.4 mm) of brake pad. If you see less than this, you may want to replace the pads.

23.4 Check Brake Fluid Level and Leak Check

Inspect the level of the brake fluid before each operation and look for leaks if the brake fluid is found to be low. The brake fluid reservoir is located at the rear of the engine bay on the driver's side.

1. Position the ROXOR on a flat level surface.
2. Verify the engine is off and parking brake set.
3. The brake fluid level should be between the upper MAX and lower MIN level lines. (Refer to the below image)

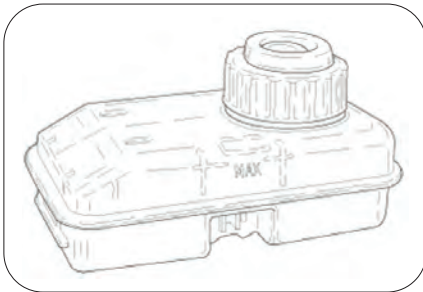

4. If the brake fluid level is lower than the MIN level line, clean the cap prior to removal, then add brake fluid until the fluid level is near the MAX line.
5. After reinstalling cap, apply pressure to the brake pedal for a few seconds, next check for fluid leakage around the six main components and their fittings.

WARNING

After opening a bottle of brake fluid, always discard any unused portion. Never store or use a partial bottle. Brake fluid is hygroscopic, meaning it rapidly absorbs moisture from the air. The moisture results in the boiling temperature of the brake fluid to drop, which can lead to early brake fade and result in severe injury or accidents.

NOTICE

Replace brake fluid any time the fluid becomes contaminated or the type of the fluid in the reservoir is unknown to prevent system damage.

23.5 Check Differential Oil Levels and Leak Check

Before checking the front and rear differential oil levels, warm them up. This is done by driving the ROXOR for 10-15 minutes.

Only perform when the ROXOR is on level ground or support. Do not use an impact wrench to remove the differential oil level plugs, this may damage the threads in the differentials resulting in a leak.

1. Clean the front and rear upper differential oil level plugs and surrounding areas. (Refer the below image)

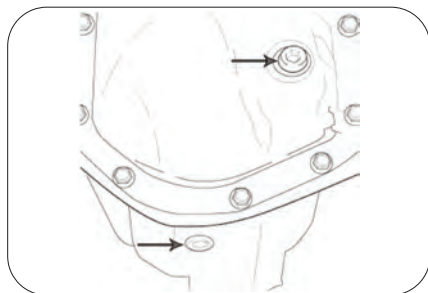

2. Remove front or rear upper differential oil level plug and verify oil is dripping out.
3. If oil is not dripping out, oil level is below the required level.
4. Add recommended oil until it begins dripping out.
5. Install and tighten the oil level plug.

23.6 Check Engine Coolant Level and Leak Check

The engine coolant level should be checked when the engine is at ambient (room) temperature. Maintain the coolant level between the HIGH and LOW lines on the coolant overflow bottle (Refer the below image).



If a leak is suspected, open the hood and check the radiator, radiator hoses and radiator hoses connected to the engine.

1. Unlatch and lift the hood, then place prop rod.
2. Push down, then slowly turn the cap counter clockwise.
3. Coolant level should be near the top of the opening.
4. If low, use a funnel and slowly add coolant as needed.
5. Reinstall the cap turning it clockwise.

⚠ DANGER

A hot engine cooling system is dangerous. Never add coolant to a hot engine coolant system, always wait for the engine to cool down first. You and others could be badly burned by steam or boiling coolant. Contact your authorized ROXOR dealer for service if your vehicle overheats.

⚠ NOTICE

Do not replace the OEM radiator pressure cap with a non-standard pressure cap. These will not allow the recovery system to function properly, causing the engine to overheat and a limited warranty claim to be denied. Your ROXOR authorized dealer can provide the correct replacement part.

23.7 Check Engine Oil Level and Leak Check

The oil dipstick is located on the passenger side of the engine. Engine oil should be checked on a level surface, with engine cold, or allow time for the oil to drain back into the oil pan before checking level to prevent overfilling.

1. Position the ROXOR on a flat level surface.
2. Stop the engine and allow time to cool.
3. Unlatch and lift the hood, then place prop rod.
4. Remove the dipstick. Wipe it dry with a clean cloth.
5. Reinstall the dipstick, then remove it and check the oil level.
6. Maintain the oil level in the safe range, between the two notches. (Refer to the below image) Do not overfill.



23.8 Check Power Steering Oil Level and Leak Check

The power steering reservoir is in the rear of the engine bay, on the driver's side. The fluid level in the reservoir should be checked on a level surface with the engine OFF to prevent injury from moving parts and to ensure accurate fluid level reading. Use only the power steering fluids recommended to help avoid damage to the power steering system. Replacing the power steering fluid should always be done by a ROXOR authorized dealer.

1. Start the engine and let it run until it reaches normal operating temperature.
2. Put transmission in neutral and set parking brake.
3. Unlatch and lift the hood, then place prop rod.
4. While engine idles and with power steering cap on, turn the steering wheel lock (left) to lock (right) a couple of times.
5. Turn the engine off.
6. Check the power steering fluid level in the reservoir.
7. The fluid level should be maintained between the MIN and MAX lines on the side of the power steering fluid reservoir. (Refer to the below image)

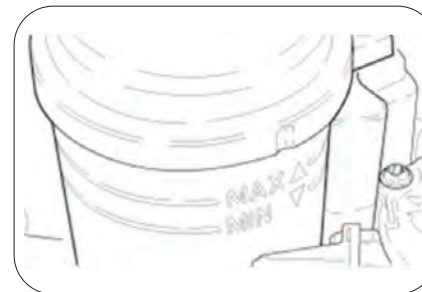

8. If fluid is low, add fluid in small amounts, remember to replace the cap and repeat steps 1 through 5.
9. Continue to follow these steps until the level reaches the correct operating range.
10. Always check for leaks if fluid level cannot be maintained.

WARNING

Driving the ROXOR with power steering fluid below the minimum mark will damage the steering system which would void all of your warranty coverage.

NOTICE

Clean spillage from all exposed surfaces with a clean cloth to prevent surface damage.

23.9 Check Tire Pressure

Keep tires properly inflated. Proper tire inflation pressure is essential to the safe and satisfactory operation of your ROXOR. The factory installed tires are recommended to be inflated to 28 psi and may be used for towing and plowing.

Four primary areas are affected by **improper** tire pressure:

- Safety
- Stability
- Ride Comfort
- Fuel Economy

It is recommended to check your tire pressure (including spare if equipped) when tires are cold. If the tire pressure is not correct, drive slowly to the nearest service station and inflate to the recommended pressure. Always reinstall the valve stem cap after checking or adjusting tire pressure. Your ROXOR is originally equipped with tires supplied by a reputable manufacturer. If you ever have questions regarding your tires, please refer to the tire warranty and literature supplied by the tire manufacturer. You may also contact the tire manufacturer or MAgNA directly.

WARNING

Improperly inflated tires can adversely affect handling or fail unexpectedly, resulting in an accident and / or personal injury. Always inflate to the recommended tire pressure.

WARNING

Never overload your ROXOR. Overloading can result in tire failure, affect handling, and increase your stopping distance, resulting in an accident and/ or personal injury.

NOTICE

Lost valve stem caps should be replaced as soon as possible. Missing valve stem caps allow dirt and moisture to get into the valve stem core and result in air leakage.

NOTICE

Any changes to factory installed wheel and tire size will adversely affect the operation of this unit's Dash Cluster and Engine Control Unit (ECU). Altering the Dash Cluster and/or ECU may cause driveability issues and potentially void the unit's warranty. Consult an authorized ROXOR Dealer for more information.

23.10 Check Transfer Case Oil Level and Leak Check

Before checking the transfer case oil, it should be warmed up by driving the ROXOR for 10-15 minutes.

Only perform when the ROXOR is on level ground or support. Do not use an impact wrench to remove the transfer case oil level plugs. This may damage the threads in the transfer case resulting in a leak.

1. Clean the transfer case oil level plugs and surrounding area. (Refer to the below image)

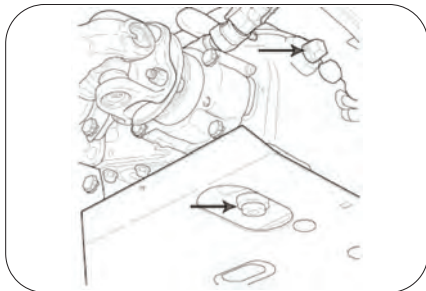

2. Remove the transfer case oil level plug (upper) and check whether oil is dripping out.
3. If oil is not dripping out, oil level must be below the required level.
4. Add specified oil to bring it up to the level that it starts dripping out.

5. Install and tighten the oil level plug.

23.11 Drain Fuel/ Water Separator

A Water-In-Fuel indicator light is provided in the multifunction gauge on the dash panel. Follow the steps below to drain the fuel/ water separator and turn off the indicator light.

This device is located on the driver's side of the engine bay, behind the headlight and radiator support. (Refer to the below image)

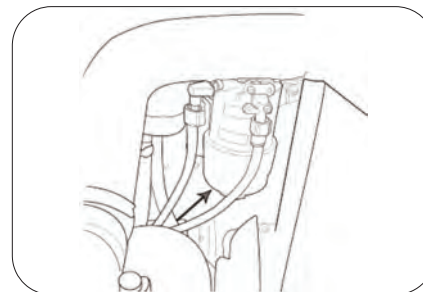

1. Place a catch basin under the water/ fuel separator.
2. Turn the fuel drain petcock counter clockwise until water begins to come out. (Refer to the below image)

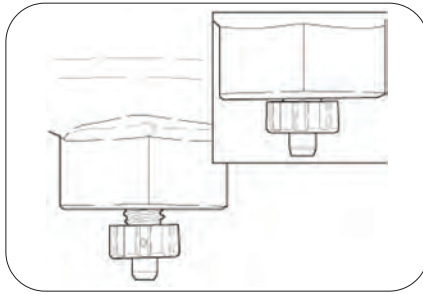

3. Turn the petcock clockwise to stop the flow of diesel fuel.

⚠ WARNING

Wear protective gloves and OSHA approved eye protection when performing this procedure to help prevent injury.

⚠ WARNING

Always dispose of drained fluid properly to prevent environmental damage.

⚠ NOTICE

Clean fuel spilled on exposed surfaces with a clean cloth.

23.12 Lubricate Shift Linkage

Lubricate the shift linkage as needed when shifting becomes difficult, after excessive water exposure to the undercarriage, or when there is excessive exposure to the effects of salt air. Apply a quality Fluoropolymer penetrating lubricant or PTFE lubricant to shift linkage pivot points. (Refer to the below image)

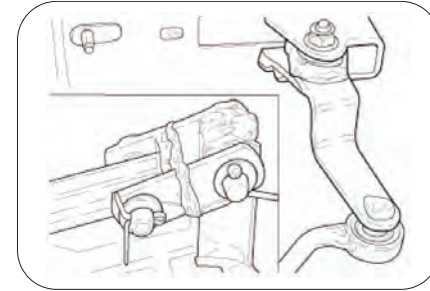

23.13 Accessory Drive Belt Tension/Replacement

Inspect the accessory drive belts periodically for cracks and abnormal wear. It is a good idea to carry an extra belt, especially as your ROXOR ages, as broken alternator belt can leave you stranded.

Alternator Belt

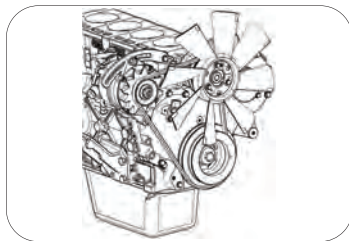

Power Steering Belt

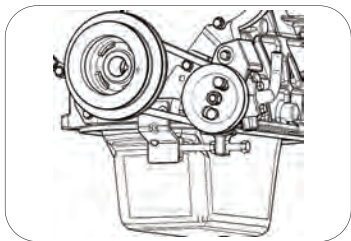

1. Position the ROXOR on a flat level surface.
2. Verify the engine is off and parking brake set.
3. Loosen the pivot bolt and lock bolt / nut.
4. If replacing belt, move the component toward the engine to remove the old belt.
5. Tension belt by moving component away from engine with adjustment screw or pry bar. Belt should have about $\frac{1}{4}$ to $\frac{1}{2}$ " (6.35 to 12.7 mm) of deflection when pushed between longest belt span.
6. Tighten locking bolt / nut and pivot bolts.

Compressor Belt (if equipped with HVAC)

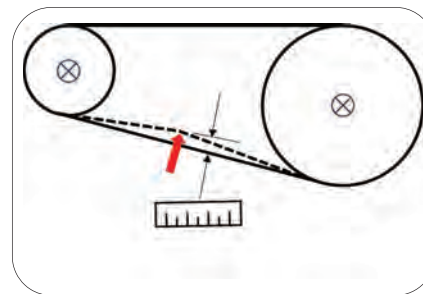
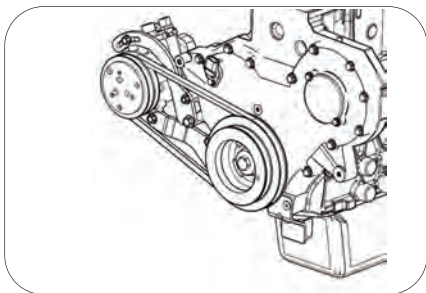

23.14 Replace Engine Air Filter

Service the air filter more frequently if the ROXOR is operated in dusty conditions. Refer to section **22.1 Severe Dusty Conditions**. Monitor the air filter indicator with engine running only, if the red indicator is visible the filter should be replaced. (Refer to the below image)

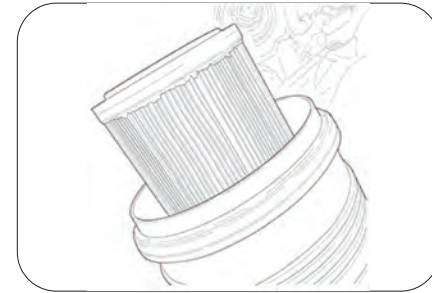

NOTICE

Operating a turbo diesel engine with a soiled or damaged air filter can result in engine damage. Do not attempt to wash the filter. Always replace a soiled or damaged filter with a new filter.

1. Verify the engine is off and parking brake set.
2. Unlatch and lift the hood, then place prop rod.
3. Remove the air filter housing clamp mounting bolt using a 13 mm socket.
4. Swing the air filter housing clamp up and out of the way.
5. Separate the lower air filter housing from the upper air filter housing.
6. Gently remove the air filter by pulling straight out. (Refer to the below image)
7. Clean any dirt or deposits from the inside of the air cleaner housings.
8. Install the new filter into the lower air filter housing, then align arrows on upper and lower housings on re-assembly.
9. Reinstall the air filter housing into cradle and swing clamp into position.
10. Position the air filter housing and tighten the mounting bolt.

23.15 Replace Engine Oil and Oil Filter

Always change the oil filter and copper washer whenever changing oil.

1. Position the vehicle on a flat level surface.
2. Run the engine for two to three minutes until warm.
3. Stop the engine, place the gear selector in gear and set the parking brake.
4. Clean the area around the drain plug. (Refer to the below image)

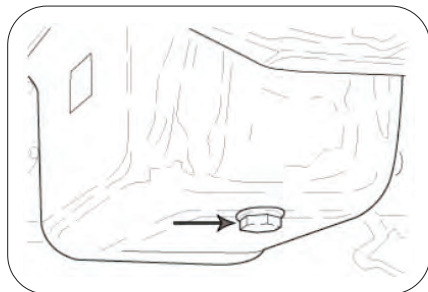

5. Place a drain pan beneath the engine crankcase.

WARNING

Contact with hot oil can result in skin burns. Do not allow hot oil to contact skin.

6. Remove the drain plug. Allow the oil to drain completely.
7. It is recommended to remove and replace the copper sealing washer. The sealing surfaces on drain plug and crankcase should be clean and free of burrs, nicks or scratches.
8. Reinstall the drain plug and a new copper sealing washer. Torque between 30-40 Nm.
9. Place shop towels beneath the oil filter. Using an oil filter wrench, turn the filter counterclockwise to remove it. (Refer to the below image)

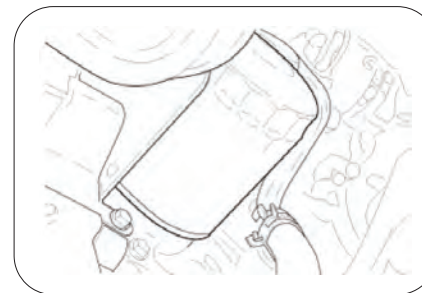

10. Using a clean dry cloth, clean the filter sealing surface on the crankcase. And verify the old o-ring is not stuck to the engine block.
11. Lubricate the o-ring on the new filter with a film of fresh engine oil. Check to make sure the o-ring is in good condition.
12. Install the new filter and turn by hand until the filter gasket contacts the sealing surface, then turn an additional 1/2 turn.

13. Unlatch and lift the hood, then place prop rod.
14. Remove the oil fill cap and add up to 7.4 Quarts (7.0 Liters) of the recommended oil.
15. Reinstall the oil fill cap.
16. Start the engine and check for leaks.
17. Stop the engine and wait for 15 seconds before removing the dipstick. Remove the dipstick. Wipe it dry with a clean cloth.
18. Reinstall the dipstick completely. Remove the dipstick and check the oil level.
19. Remove the oil fill cap and add oil as needed to bring the level to the upper mark on the dipstick. Do not overfill.
20. Reinstall the fill cap. Reinstall the dipstick.
21. Dispose of used filter and oil properly.

23.16 Replace Transfer Case Oil

1. Clean the oil level plug, drain plug and surrounding area.
2. Place a container to collect oil, under the transfer case.

3. Remove the lower oil drain plug. (Refer to the below image)

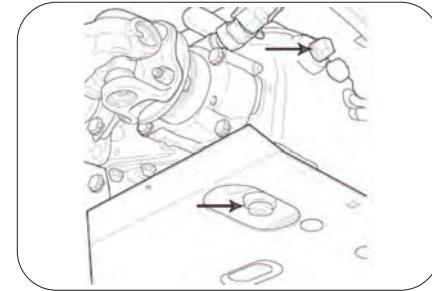

4. Remove the upper oil level plug.
5. Let the oil drain out.
6. Clean and reapply thread sealant. Install and tighten the drain plug.
7. Fill new oil through oil level plug using a funnel until it begins to drip out.
8. Install and tighten the oil level plug.

WARNING

Always dispose of drained fluid properly to prevent environmental damage.



23.17 Rotate Wheels and Tires

When rotating the tires, make sure the ROXOR is on level ground and properly supported. Never place your body or limbs underneath the ROXOR when supported. Follow the rotational pattern below. (Refer to the below image)

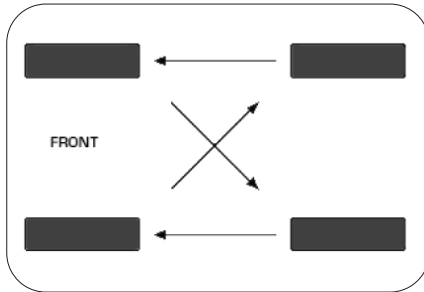



24 Vehicle Care

24.1 Post Operation Care

You should rinse the dirt and debris off of the ROXOR with fresh water at the end of each operating day. Apply a rust inhibiting penetrating oil on unpainted metallic parts, excluding belt pulleys and brake components. When the vehicle is operated in muddy conditions, a complete wash is recommended to help preserve its components.

NOTICE

When the ROXOR is used near salt-water environments, rinsing the vehicle with fresh water becomes more critical. Never use a high-pressure washer to clean.

24.2 Vehicle Cleaning and Protection

When required, wash with a soft sponge or cloth, warm water and a mild detergent. Use low pressure water only (like a garden hose) for cleaning. High pressure can cause damage to electrical or mechanical components. Certain areas can collect mud and debris, potentially causing abnormal wear, interferences or promote corrosion. Use a nonabrasive wax to protect gloss painted surfaces only. Wax should not be used on matte painted surfaces.

NOTICE

Never clean plastic parts with strong detergent, degreasing agent, paint thinner, acetone, etc.

24.3 Metal and Rust Prevention

Cover nicked, scratched or damaged areas with touch-up paint or other suitable rust inhibitor to prevent rust. Keep body drain holes free from packed dirt. Apply anti-corrosion spray to the underbody to avoid rusting and corrosion especially for vehicles in coastal areas.

NOTICE

High pressure water can wash the grease from wheel bearings, it may also enter the transmission and/or transfer case reducing the lubricating qualities of the oil. If these components are submerged in water or found to have water mixed with the lubricant, replace lubricant to prevent rusting and premature failure.

24.4 Storage and Preseason Preparation

When the ROXOR will not be used for 4 months or longer, proper storage is recommended. See a ROXOR authorized dealer, repair shop, or person of your own choosing to have it properly prepared and inspected before and after storage. When bringing the ROXOR out of storage, it is also recommended to complete the checklist in section **9.1 PreRide Inspection Checklist**.

NOTICE

Due to minor parasitic load, the battery should be removed or disconnected if your ROXOR will be stored for more than 1 month.

Hooking up a battery tender to the battery is also recommended.

25 Technical Information

25.1 Product Identification Number

The ROXOR's main components (body, frame and engine) are identified by serial numbers. These numbers are also required to complete a limited warranty claim. We strongly recommend taking note of these numbers and supply them to your insurance company, in the event your vehicle is stolen. The Product Identification Number (PIN) is a 17 digit number, listed on a label located in the engine compartment, on the driver's side of the bulkhead. (Refer below image)

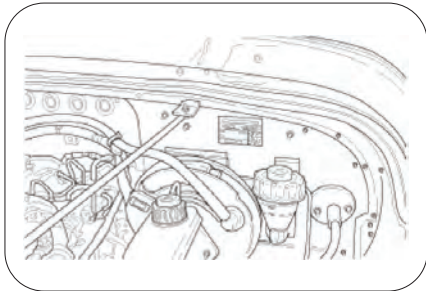

25.2 Engine Identification Number

The engine identification number is a 10 digit number, located on a machined pad, on the front driver's side of the engine block. (Refer below image)

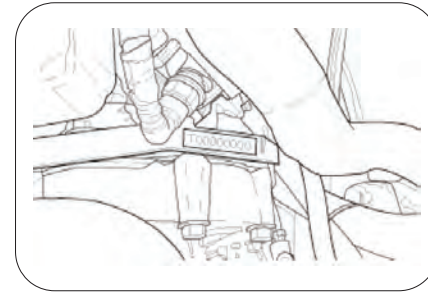

25.3 Noise Emission Control System

Tampering with the noise emission control system is prohibited. U. S. Federal laws and Canadian provincial laws may prohibit the following acts or the causing thereof; removal or rendering inoperative by any person other than for purposes of maintenance, repair or replacement, of any device or element of design, incorporated in the ROXOR for the purpose of noise control prior to its sale or delivery to the ultimate purchaser or, while it is in use or, the use of the vehicle after such device or element of design has been removed or rendered inoperative by any person.



25.4 Acts Presumed to Constitute Tampering

As a certifying manufacturer, MAgNA may deny warranty claims only for failures that have been caused by the owner's or operator's improper maintenance or use, by accidents for which MAgNA has no responsibility, or by acts of God.

- Removal or alteration or the puncturing of the muffler or any engine component which conducts removal of engine exhaust gases.
- Removal or alteration or the puncturing of any part of the intake system.
- Replacing any moving parts of the ROXOR or parts of the exhaust or intake system, with parts other than those specified by the manufacturer.
- Any other act prohibited by the clean air act and its exacting regulations, including; modifying exhaust emissions, control devices and/ or Engine Control Unit (ECU)



26 Specifications

26.1 Fluid Specifications and Quantities

Fluid Type	Type	Volume
Fuel - Diesel	15ppm sulfur On Road Diesel	16 gal
Engine Oil - Diesel	5W40 API CK4	7.4 qts / 7.0 L
Engine Coolant - Diesel	Low / No Silicate 50/50 Anti-Freeze	8.5 qts / 8.0L
Clutch Fluid	FVMSS 116 DOT 4 (DOT 3 Opt)	0.21 qts / 0.20 L
Brake Fluid	FVMSS 116 DOT 4 (DOT 3 Opt)	0.95 qts / 0.90 L
Manual Transmission Fluid	GEAR OIL SAE 80W-90 API GL-5	2.1 qts / 2.0 L
Transfer-Case Fluid	GEAR OIL SAE 80W-90 API GL-5	1.7 qts / 1.6 L
Front Differential	GEAR OIL SAE 80W-90 API GL-5	1.9 qts / 1.8 L
Rear Differential	GEAR OIL SAE 80W-90 API GL-5	1.9 qts / 1.8 L
Power Steering Fluid	ATF TYPE III H (DEXRON III or equivalent)	0.63 qts / 0.60 L
Leaf Spring Pivots	NLGI-3 (Multipurpose Lithium Grease)	As Required
Shift Linkage and Cables	PTFE Lubricant	As Needed
U-Joints	NLGI-2	As Needed
Wheel Bearings	NLGI-2	As Needed



26.2 Vehicle Specifications

Dimensions and Capacities	
Wheelbase	96" (2.44 m)
Dry Weight	2988 lbs. (1355 kg)
Length	148" (3.76 m)
Width	60" - 62" (1.57 m)
Height	75" (1.91 m)
Ground Clearance	9" (22.9 cm)
Fuel Capacity	16 gal. (60.6 l)
Turning Radius	20'
Vehicle Payload Capacity	1525 lbs. (692 kg)
Towing Capacity	3500 lbs. (1588 kg)
Engine	
Type	Turbo Diesel
Cylinders	4 - 4 Stroke Compression Ignition
Displacement	2.7L / 166.7 Cu. In.
Bore and Stroke	3.5" x 4.33" (88.9 x 110 mm)
Power	55 HP @ 2300
Torque	144 ft. lbs. @ 1400 rpm
Compression Ratio	18.7
Cooling System	Liquid



Fuel System	Direct Injection
Manual Drivetrain	
Transmission	5 Speed Manual
Transfer Case	2 Speed
Driveline	2WD / 4WD
Full Floating Front Axle	5.38:1
Semi Floating Rear Axle	5.38:1
Chassis and Suspension	
Chassis Type	Box Steel Frame (10 ga.)
Front Suspension	Leaf Spring w/ Shock Absorbers & Stabilizer Bar
Rear Suspension	Leaf Spring w/ Shock Absorbers
Shock Absorbers	Double Acting Hydraulic
Dual Hydraulic Vacuum Assist	Standard
Parking Brake	Standard
Front Brakes	11" Disc
Rear Brakes	11" Drum
Features	
Steering	Hydraulic Power
Instrumentation	Single Gauge
Lighting / HeadLights	Halogen
Battery	600 CCA/ 12v Standard

Specifications



Alternator	45 — 90 Amp Maximum
Power Port	12V Standard
Storage	2 Seat Boxes
Tires	235 / 70R16
Wheel / Steel	16" - 5 x 5.5 Lug
Wheel / Aluminium (Optional)	16" - 5 x 5.5 Lug
Performance	
Maximum Speed	52 mph (rpm limited)
Maximum Towing Speed	15 mph
Country of Final Assembly	USA

27 Troubleshooting

Troubleshooting Table	
Possible Causes	Solution
Engine Doesn't Turn Over	
Low battery voltage	Recharge the battery
Loose battery connections	Check battery connections, clean and tighten
Loose starter solenoid connection	Check starter connections, clean and tighten
Loose fuse box connections or blown fuse	Remove, inspect and reinstall related fuses
Engine Turns Over, Fails to Start	
Out of fuel	Refuel
Clogged fuel filter/water separator	Drain water separator, inspect and/or replace fuel filter
Clogged air filter	Inspect and/or replace air filter
Water is present in fuel	Drain the fuel system and refuel, replace fuel filter/water separator
Old or non-recommended fuel	Replace with fresh recommended fuel
Water or fuel in crankcase	See your local ROXOR dealer for assistance

Troubleshooting Table	
Possible Causes	Solution
Low battery voltage	Recharge the battery
Mechanical failure	See your local ROXOR dealer for assistance
Defective fuel pump	Inspect and/or replace
Engine Runs Irregularly, Stalls or Misfires	
Poor or incorrect fuel	Replace with recommended fuel
Low fuel level	Refuel
Clogged fuel filter	Inspect and/or replace fuel filter
Clogged air filter	Inspect and/or replace air filter
Water present in fuel	Drain water separator, inspect and/or replace fuel filter
Kinked or plugged fuel tank vent line	Inspect and/or replace
Other mechanical failure	See your local ROXOR dealer for assistance
Engine Stops or Loses Power	
Poor or incorrect fuel	Replace with recommended fuel
Air leak in system after turbocharger	Inspect for leaks and repair as required



Troubleshooting Table	
Possible Causes	Solution
Boost pressure sensor stuck open	Check sensor condition and repair or replace
Clogged fuel filter	Inspect and/or replace fuel filter
Clogged air filter	Inspect and/or replace air filter
Water present in fuel	Drain water separator, inspect and/or replace fuel filter
Kinked or plugged fuel tank vent line	Inspect and/or replace
Turbocharger damaged	Inspect and/or replace turbocharger
Other mechanical failure	See your local ROXOR dealer for assistance
Out of fuel	Refuel
Low battery voltage	Recharge the battery
Overheated engine	Clean radiator screen and core, clean engine exterior, operate at lower load
Engine Smokes (Black)	
Air leaks between turbocharger/intake manifold	Check for leaks in the air intake system, repair leaks (check o-rings, clamps, hoses)
Air intake restriction	Inspect and/or replace air filter

Troubleshooting Table	
Possible Causes	Solution
Excess Oil Consumption	
Clogged air filter	Inspect and/or replace air filter
Obstruction in crankcase ventilation	Locate and remove the restriction
Intake manifold mounting face leak	Change the manifold gasket or replace the manifold
Air leaks between turbocharger/intake manifold	Check for leaks in the air intake system, repair leaks (check o-rings, clamps, hoses)
Excessive oil/sludge in turbocharger	Change oil and oil filter, service the turbocharger and use recommended engine oil
Turbocharger damaged	Inspect and/or replace turbocharger
Whining Noise at 2000 RPM	
Air leakage between turbocharger/inlet manifold	Check for leaks in the air intake system, repair leaks (check o-rings, clamps, hoses)



28 Limited and EPA Warranties U.S. and Canada

28.1 Mahindra Emissions Control Warranty Policy

CALIFORNIA AND FEDERAL EMISSION CONTROL WARRANTY STATEMENT YOUR WARRANTY RIGHTS AND OBLIGATIONS

The California Air Resources Board, U.S. Environmental Protection Agency ("EPA") and MAgNA are pleased to explain the emission control system warranty on your heavy-duty off-road engines. In California ("the State") and US EPA regulated applications, new heavy duty off-road engines must be designed, built and equipped to meet the State's and US EPA's stringent anti-smog standards. MAgNA must warrant the emission control system on your engine for the periods of time listed below provided there has been no abuse, neglect or improper maintenance of your engine.

Your emission control system may include parts such as the fuel injection system and the air induction system. Also included may be hoses, belts, connectors and other emission-related assemblies.

Where a warrantable condition exists, MAgNA will repair your heavy-duty off-road engine at no cost to you including diagnosis, parts and labor. If inspection by a certified MAgNA service center reveals that the failure is not a result of a defect in material or workmanship, the purchaser will be responsible for all costs of exploratory dismantling and diagnosis.

MANUFACTURER'S WARRANTY COVERAGE:

The heavy-duty off-road engines are warranted for the period of 5 years or 3000 hours. If any emission-related part on your engine is defective, the part will be repaired or replaced by MAgNA

OWNER'S WARRANTY RESPONSIBILITIES:

As the off-road engine owner, you are responsible for the performance of the required maintenance listed in your owner's manual. MAgNA recommends that you retain all receipts covering maintenance on your off-road engine, but MAgNA cannot deny warranty solely for the lack of receipts or for your failure to ensure the performance of all scheduled maintenance.

- As the off-road engine owner, you should however be aware that MAgNA may deny you warranty coverage if your off-road engine or a part has failed due to misuse, abuse, vandalism, neglect, improper, accident, submersion, improper maintenance or unapproved modifications.

Your engine is designed to operate on Ultra Low Sulfur Diesel fuel only. Use of any other fuel may result in your engine no longer operating in compliance with California's emissions requirements.

- You are responsible for initiating the warranty process. You must present your off-road engine to a MAgNA dealer as soon as a problem exists. The warranty repairs should be completed by the dealer as expeditiously as possible, not to exceed 30 days.
- You may choose any qualified repair shop or person to maintain, replace, or repair emission control devices and systems with original or equivalent replacement parts. However,



warranty, recall and all other services paid for by MAgNA must be performed at an authorized MAgNA service center

If you have any questions regarding your warranty rights and responsibilities, you should contact MAgNA toll free at 1-(877)449-7771 or go to MAgNA's website below.

<https://www.mahindrausa.com/contactemail-tractors-utvs-farming-equipment-dealership-contact-us>

COVERAGE:

Parts/components that are scheduled to be replaced as part of the required maintenance schedule will be covered under the warranty provisions for a period of time up to the first scheduled replacement point for the subject parts/components. Subsequent damage to other engine components as a direct result of a warrantable failure of an exhaust emission control System part/component will be covered under the warranty provisions described herein.

MAgNA will repair or replace emission control system parts, components and sub-assemblies found to be defective with respect to materials or workmanship at no cost to you including engine exhaust system related diagnosis, labor and parts. The choice and responsibility of the decision to repair or replace an emission control system defect will be solely that of MAgNA. Emission control system parts/ components covered by the Federal and California Emission Control Systems Limited Warranty are listed below (if equipped).

Components Covered : The emission-related warranty covers all components whose failure would increase an engine's emissions of

any regulated pollutant, including but not limited to the following listed components.

Emission Control Systems Limited Warranty are listed below (if equipped) and as related to emission controls:

1. Air Induction System

- Intake Manifold
- Turbocharger System
- Charge Air Cooling System [Intercooler]

2. Catalyst or Thermal Reactor System

- Catalytic converter
- Exhaust manifold

3. Fuel Injection System

- Fuel Supply Pump (Common Rail System)
- Injector
- Injection Pipe
- Common Rail
- Smoke Puff Limiter
- Speed Timer
- Cold Advance Timer
- Injection Pump



4. Electronic Control System

- ECU
- Engine Speed/ Timing Sensor
- Accelerator Position Sensor
- Coolant Temperature Sensor
- Atmospheric Pressure Sensor
- Intake Pressure Sensor
- Intake Manifold Temperature Sensor
- Intake Air Flow Sensor
- Common Rail Pressure Sensor

5. Exhaust Gas Recirculation System

- EGR Valve
- EGR Cooler
- EGR Valve Opening Rate Sensor

6. Particulate Controls

- Any device used to capture particulate emissions
- Any devices used in the regeneration of the particulate control
- Control Device Enclosures and Manifolds
- Differential Pressure Sensor

7. Advanced Oxides of Nitrogen(Nox) controls

- Selective Catalytic Reduction (SCR) Catalyst
- Reductant (urea) Containers
- Dispensing Systems
- NOx Sensor
- SCR Temperature Sensor
- Any Sensor for Diesel Exhaust Fluid

8. Miscellaneous Items

- Closed Breather System
- Hoses Clamp Fittings, Tubing (whose failure affects exhaust emissions)
- Gaskets Seals
- MAgNA supplied engine Wiring Harnesses
- MAgNA supplied engine Elec: Connectors
- Air Cleaner Element* Fuel Filter Element*
- Emission Control Information Labels

*Until the first scheduled replacement point

Emission-related components also include any other part whose only purpose is to reduce emissions or whose failure will increase emissions without significantly degrading engine/equipment performance.

*As related to the evaporative emission control system



Limited Applicability

MAGNA may deny emission-related warranty claims for failures that have been caused by the owner's or operator's improper maintenance or use, by accidents for which the manufacturer has no responsibility, or by acts of God. For example, an emission-related warranty claim need not be honored for failures that have been directly caused by the operator's abuse of the engine/equipment or the operator's use of the engine/equipment in a manner for which it was not designed and/or not attributable to the manufacturer in any way.

Notice Specifically For Canada Owners

The provisions contained in this written warranty are not intended to limit, modify, take away from, disclaim or exclude any warranties set forth in the operation of The Consumer Products Warranties Act, 1977 (Saskatchewan), the Consumer Protection Act (Quebec), or any other similar provincial or federal legislation. Your ROXOR authorized dealer has ensured that all systems and components of your ROXOR are operating according to manufacturer's specifications. As part of the delivery of your new ROXOR, your Dealer has explained maintenance requirements, operations and warranty conditions assuring that you received all standard items including your owner's manual, warranty policy and owner registration form. Please present your copy of the Owner Registration to your Dealer's service department when service or warranty repairs are required.



29 Contact Us

Mahindra USA, Inc d/b/a "MAGNA"

Website: WWW.ROXOROFFROAD.COM

Phone: (877) 449-7771



30 Privacy Information

Please be informed that MAGNA may use your registration information for safety and limited warranty related purposes. MAGNA and its partners may also use its customer data to distribute marketing and promotional information about MAGNA and related products. To verify and correct your data, or to be removed from the distribution list for direct marketing, please contact us.

Mahindra USA, Inc d/b/a "MAGNA"

9020 Jackrabbit Road, Houston, TX 77095

Main: (877) 449-7771



31 Change of Address/Ownership

If your address has changed or if you are the new owner of the ROXOR, be sure to follow the steps below:

1. Reach out to your local dealer. If you do not know who your local dealer is:
 - Go to roxoroffroad.com then Locate a dealer.
 - Contact (877) 449-7771 and provide your zip code.
2. The dealer will need
 - Serial number
 - Name of owner
 - Address
 - Possible photo of serial number plate
 - Bill of sale maybe required



32 Stolen Units

If your ROXOR is stolen, you should notify local law enforcement immediately. Then notify MAGNA., or a ROXOR authorized dealer. You will be asked to provide your Name, Address, Phone Number, the Product Identification Number (PIN) and the Date it was stolen. Refer to section 29 Contact Us for MAGNA addresses and phone numbers.

Vehicle Serial Number:	
Engine Serial Number:	
Insurance Information	
Local Dealership Contact:	
Date of Purchase:	

mahindra **ROXOR HDUV**



ROXOR HDUV
Base Model



ROXOR HDUV
All-Weather Model

Mahindra USA, Inc
9020 Jackrabbit Road
Houston TX 77095
(877) 449-7771

ROXOROFFROAD.COM

Mahindra USA, Inc. reserves the right to change the stated specifications without notice. This brochure is for descriptive purposes only and reasonable efforts were made to verify the information contained in it. Some items shown may be optional and some machinery shown may not be available at all dealers. Mahindra disclaims all representations and warranties, express or implied, or any liability from the use of this brochure. For complete warranty, safety, and product information, consult your local Mahindra dealer and the product operation manual. Engine power (hp/kw) and other specifications are based on various standards and best practices. This brochure is intended for the United States and its territories only. For more information visit our website.

LEARN MORE



11/21/2023